

客服热线: 400-830-3938 800-830-3938

CASTLE 系列

20KS -200KS

使用手册

USER MANUAL

 **SANTAK**[®]

感谢您使用山特产品!

请严格遵守本手册中和机器上的所有警告及操作说明，并妥善保管本手册。在没有阅读完所有的安全说明和操作说明以前，请不要操作本机。

本手册适用于**3C3 PRO**系列产品，包括：

3C3 PRO 20KS

3C3 PRO 30KS

3C3 PRO 40KS

3C3 PRO 60KS

3C3 PRO 80KS

3C3 PRO 100KS

3C3 PRO 120KS

3C3 PRO 160KS

3C3 PRO 200KS

严正声明

监管码声明

为了切实保障您的消费权益和用电安全，帮助您购买到真正的山特UPS，请注意以下事项：

1. 认准山特注册商标： **SANTAK**® 山特®
2. 山特电子（深圳）有限公司在中国从未以任何形式授权委托其它公司生产UPS；
3. 山特所有产品机身上均贴有“电子监管码”（“电子监管码”是国家质检总局为打击假货推行的一种产品身份识别码）。

查询方式：

网站查询：登录www.95001111.com（中国产品质量电子监管网），输入监管码进行查询；

电话查询：95001111进行查询（未开通地区可拨打010-95001111）；

短信查询：编辑监管码发送至106695001111（移动、联通均可）；

如有疑问，请拨打电话95001111或登录www.95001111.com点击“消费者通道”进行举报投诉。

版权声明

山特公司致力于技术创新，不断提供更好的产品和服务满足客户需求，我们将保留对产品设计、技术规格、使用手册更新的权利，恕不另行通知。产品以实物为准。

请登录www.santak.com.cn下载最新版的产品说明书。

版权所有 © 2019-2023山特电子（深圳）有限公司

安全注意事项

操作安全

1. 在使用本产品前，请仔细阅读“安全注意事项”，以确保正确和安全的使用。并请妥善保管此手册。
2. 操作时，请注意所有警示标记，并按要求进行操作。
3. 请勿在阳光直接照射、雨淋或潮湿的环境使用本设备。
4. 本设备不能安装在靠近热源区域，或电暖炉、热炉等类似设备的附近。
5. 放置UPS时，四周要留有安全距离，保证通风散热及产品维护。安装时，请参照此手册。
6. 清洁时，请使用干燥的非导电物品进行擦拭。
7. 若遇火警，请正确使用干粉灭火器进行灭火。禁止使用液体灭火器。
8. 安装前要考虑楼层对机器和电池组的承重能力。
9. 使用本设备前，请确保负载功率与UPS额定功率及所配电池规格相匹配。

禁止事项

1. 电源设备内部有高压，非本公司或未经本公司授权的技术人员，请勿擅自打开机箱盖，否则会有触电的危险，同时失去保修资格。
2. 应用于下述负载设备前，请先与经销商或山特公司讨论；其应用、设置、管理和维护等必须有特别的考虑和设计：
 - A.精密工业、科学和医疗仪器、设备；
 - B.电梯等有可能危及人身安全的设备；
 - C.启动电流很大且产生负功的负载设备；
3. 电池严禁置于火中，以免爆炸。

电气安全

1. 上电前，请确认已正确接地，并检查配电路和电池极性的正确性。
2. 电池保护装置需配置额定规格的过流保护断路器。
3. 当UPS需要移动或重新配线时，必须保证UPS完全关机，并将输入空气开关和电池开关断开，否则输出端仍可能带电，有触电的危险。
4. 为确保安全及产品性能，请使用山特指定的附加装置和附件。
5. 客户端在连接UPS前必须在配电系统中安装额定规格值的四极过流断路保护装置，断开所有的输入线路，以防有电击危险。

电池安全

1. 蓄电池的寿命随环境温度的升高而缩短。定期更换电池可保证UPS工作正常，并保证足够的后备时间。
2. 蓄电池的更换和维护只能由具备蓄电池专业知识的被授权人员进行，必须使用相同类型和型号的蓄电池，且数量必须相同。
3. 蓄电池存在电击危险和短路电流危险。为避免触电伤人事故，在更换电池时，请遵守下列警告：
 - A.不要佩带手表、戒指或类似金属物体；
 - B.使用绝缘的工具；
 - C.穿戴橡胶鞋和手套；
 - D.请勿将金属工具或类似的金属零件放在电池上；
 - E.在拆电池连接端子前，必须先断开连接在电池上的负载。
4. 严禁将蓄电池暴露于火中，以免引起爆炸，危及人身安全。
5. 非专业人士请勿打开或损毁蓄电池，因为电池中的电解液含有强酸等危险物质，会对皮肤和眼睛都会造成伤害。如果不小心接触到电解液，应立即用大量的清水进行清洗，并去医院检查。
6. 请勿将电池正负极短路，必须在电池箱里安装过电流保护装置，以防着火或电击危险。

使用保养

1. 使用环境及保存方法对本产品的使用寿命及可靠性有一定影响，因此，请注意避免在下列工作环境中使用：
 - A.超出技术指标规定（温度0-40℃，相对湿度0-95%）的高、低温和潮湿场所；
 - B.有振动、易受撞的场所；
 - C.有金属性粉尘、腐蚀性物质、盐份和可燃性气体的场所。
1. 如果长时间放置不使用，必须将UPS（不带电池）存放在干燥的环境中，存贮温度范围：-25-55℃。UPS开机之前，必须先让环境温度回暖至0℃以上，并维持2小时以上。
2. 请保持进、排气孔的通畅。进、排气孔的通风不畅会导致UPS内部的温度升高，使机器中元器件的寿命缩短，从而会影响到整机寿命。
3. 常温下当电池长期不用，电池连续三个月未充电时，需充电一次；在高温环境下，连续两个月未充电时就需充电一次，每次不得少于10小时；切勿空载放电，电池的持续放电时间应不超过14小时。

目录

第1章 简介	1
1.1 产品简介	1
1.2 常用符号说明	2
第2章 外观介绍	3
2.1 拆包装检查	3
2.2 外观图	4
2.3 LCD面板指示说明	12
第3章 安装说明	13
3.1 安装需知	13
3.2 安装空间	13
3.3 用户功率端子位置安装图	14
3.4 3C3 PRO 系列UPS配线表和保护装置	19
3.5 并机安装	27
3.6 电池箱连接UPS的步骤	30
第4章 操作	31
4.1 单机操作	31
4.2 并机操作	39
第5章 通讯界面	40
第6章 选配件介绍	45
6.1 防尘过滤网	45
6.2 温度传感器	46
6.3 双输入电源	46
第7章 运输、维护与故障排除	47
附录一 技术参数	49
附录二 灯号参照表	51
附录三 维修保证	52

第1章 简介

1.1 产品简介

3C3 PRO系列是具有高效率、高性能的双转换、纯在线式、三进三出的UPS产品。它提供了完美的电源保护解决方案，解决了断电、市电高压、市电低压、电压瞬时跌落、减幅振荡、高压脉冲、浪涌电压、谐波失真、杂波干扰、频率波动等电源问题，使产品可以广泛的应用在计算机设备，通信设备和其他控制类设备中，并且针对冲击性负载可以加装特定的选配件来应对复杂的工业环境。因此，3C3 PRO系列产品是电信、金融、交通、政府、制造、能源等多种行业或领域的最佳选择。







3C3 PRO系列产品的多种功能可为您的设备提供高品质的电源保证：

- 先进的DSP数字控制技术，有效提升产品性能和系统可靠性
- N+X并联冗余（支持并机共用电池）
- 优秀的工业环境防护性能
- 经济、安全的ECO模式运转可使UPS的整机效率达到98%以上
- 高清晰人机交互的LCD界面，操作直观便捷
- 功能强大的通讯接口和远程监控
- 丰富的选配件，可根据实际需求灵活配置



1.2 常用符号说明

下面一些符号会在本说明书中用到，也可能会在实际应用过程中出现，请正确识别并知其含义。

符号及含义	
符 号	含 义
	注 意 安 全
	当 心 触 电
	交 流
	直 流
	保 护 接 地
	重 复 循 环
	勿 与 杂 物 一 同 放 置

第2章 外观介绍

2.1 拆包装检查

1. 打开包装，包装内应有：

1) UPS主机一台。

2) 随机附件，包括使用手册、环保信息卡和门锁钥匙两把(60-200KS)。

2. 检查UPS是否在运输中损坏，如发现损坏或部件缺少，请勿开机，立即联系承运商或经销商。

图一：剪掉打包带，移除木箱上盖板。

图二：将木箱侧板与前后板之间的插舌掰直，然后移除侧板和前后板。

图三：拆下包装材料。

图四：拆除固定在机柜前后的L型角铁。

图五：将斜坡板放置在栈板前面。

图六：将机柜沿斜坡板推下，然后移到最终安装地点。

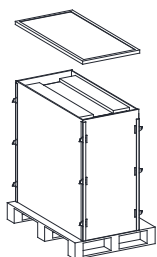

图一

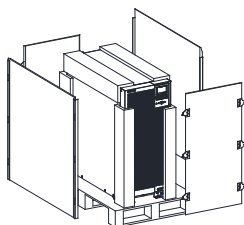

图二

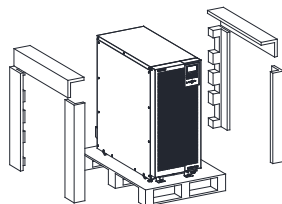

图三

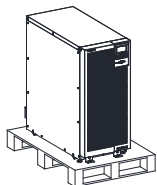

图四

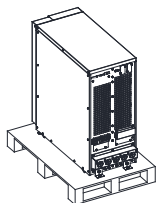

图五

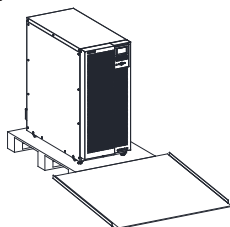

图六

2.2 外观图

3C3 PRO 20KS/30KS/40KS 外观图

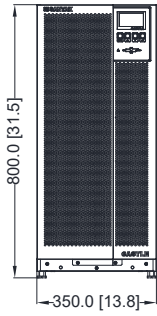

前视图

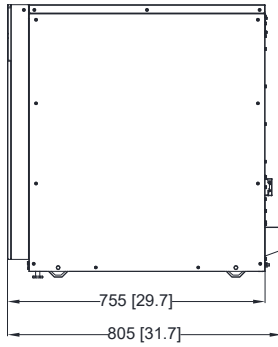

右视图

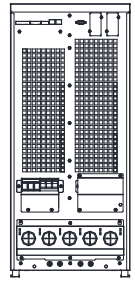

后视图



俯视图

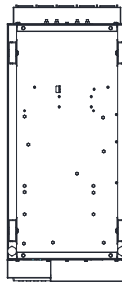

底视图

3C3 PRO 60KS/80KS 外观图

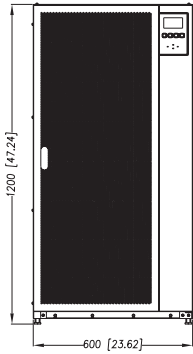

前视图

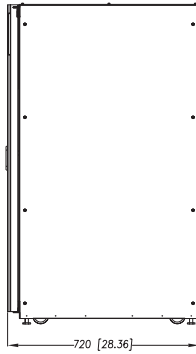

右视图

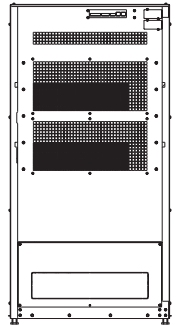

后视图

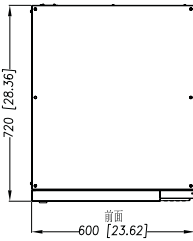

俯视图

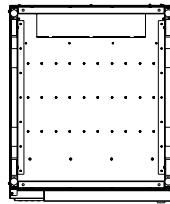

底视图

3C3 PRO 100KS 外观图

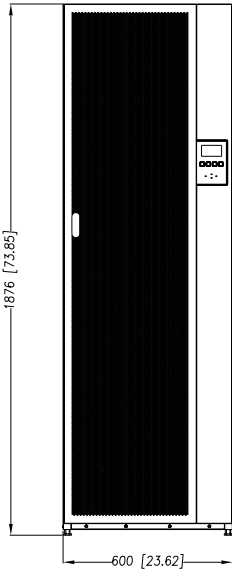

前视图

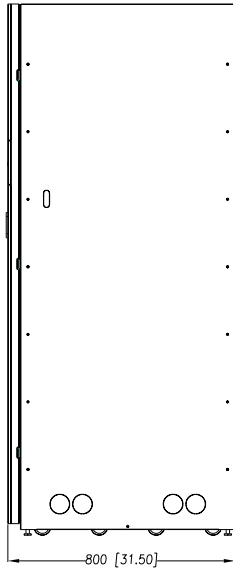

右视图

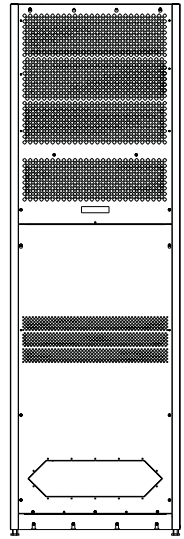

后视图

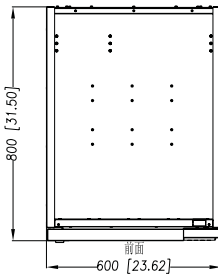

俯视图

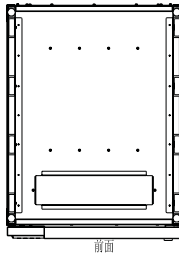

底视图

3C3 PRO 120KS 外观图

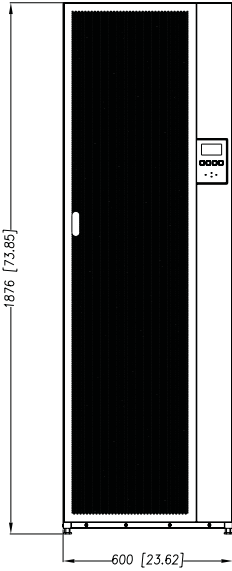

前视图

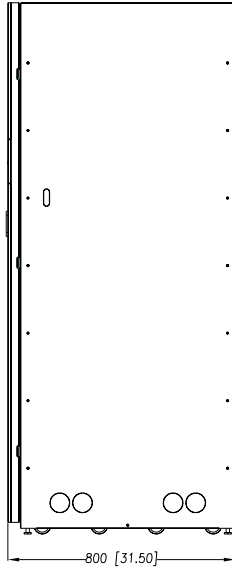

右视图

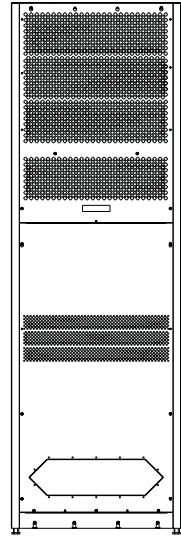

后视图

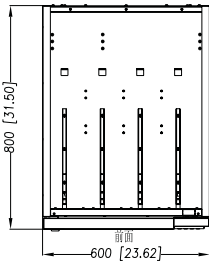

府视图

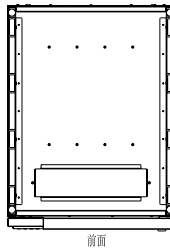

底视图

3C3 PRO 160KS/200KS 外观图

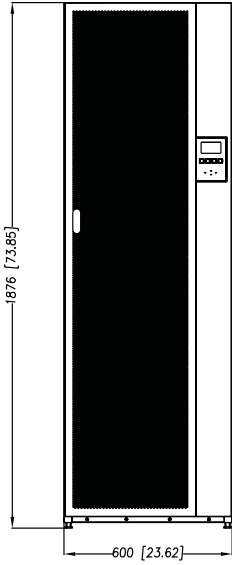

前视图

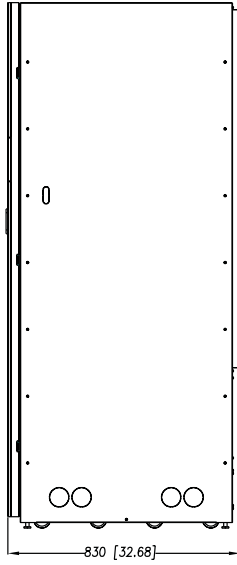

右视图

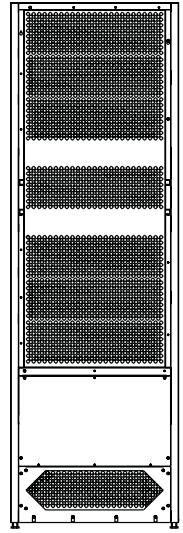

后视图

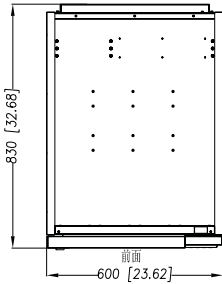

俯视图

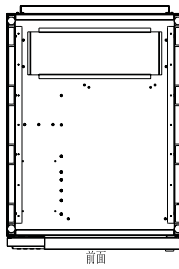

底视图

3C3 PRO 20KS/30KS/40KS 重心图

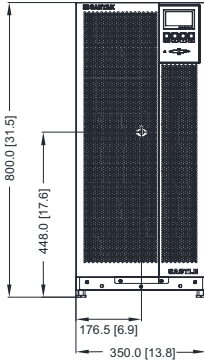

前视图

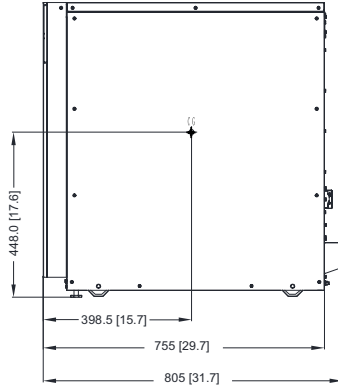

右视图

3C3 PRO 60KS/80KS 重心图

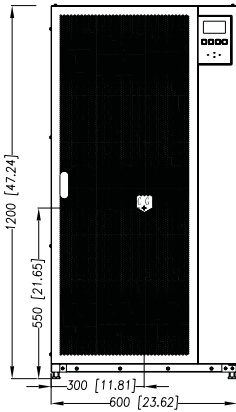

前视图

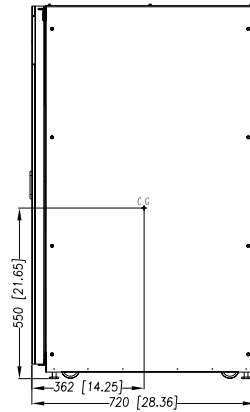

右视图

3C3 PRO 100KS/120KS 重心图

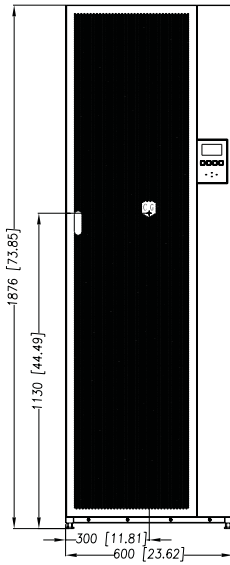

前视图

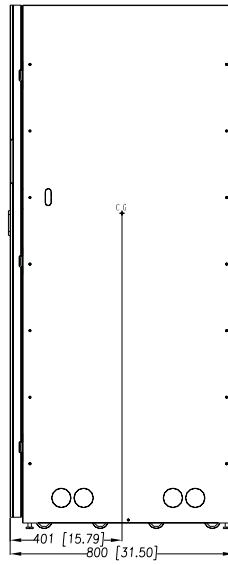

右视图

3C3 PRO 160KS/200KS 重心图

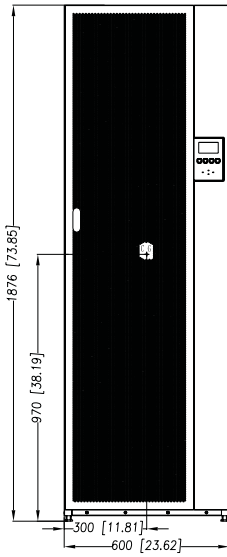

前视图

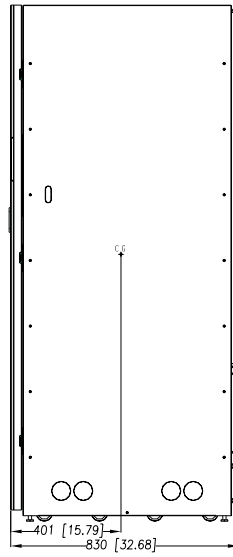

右视图

2.3 LCD面板指示说明

LCD面板是用于人机交互的界面，通过LCD面板可以对UPS进行可视化操作，为UPS开机、关机、状态显示、故障报警、参数设置等功能提供了友好的界面。UPS安装完后，用户对UPS的所有操作都可以通过LCD面板完成。LCD面板包含状态显示灯、LCD显示屏、导航键三部分。下表分别对状态指示灯和导航键按钮进行了描述。

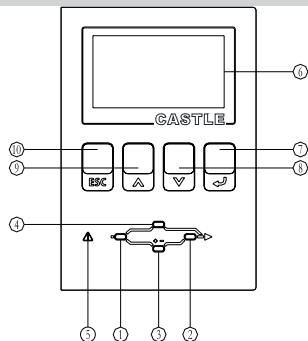

注：LED与UPS状态对应的详细信息可参考附录二。

- 状态指示灯：显示UPS当前的工作模式或状态。

标识	指示灯名称	颜色	状态
①	市电	绿色	UPS由市电供电给负载
②	逆变	绿色	UPS电源通过逆变器供电给负载
③	电池	黄色	市电输入异常，UPS由电池供电给负载
④	旁路	黄色	UPS由旁路供电给负载
⑤	故障	红灯	UPS发生异常，此灯长亮或闪烁，且发出连续或间歇的警报声。

- LCD显示屏—⑥：详细的显示UPS信息。
- 导航键：菜单项的选择、打开、获取信息，改变系统参数等。

标识	导航键	名称	功能
⑦	←	确认/输入	打开所选菜单或确定一操作；密码操作时确定此位输入，进入下一位密码输入；状态界面下按动此键回到主菜单界面。
⑧	▼	向下	同级菜单下跳跃到下一屏显示
⑨	▲	向上	同级菜单下返回到上一屏显示
⑩	Esc	退出	退出当前界面返回上一界面或取消一操作；进行密码操作时可使当前输入密码为空；主菜单界面下按动此键回到状态界面。

第3章 安装说明

3.1 安装需知

- 1) 3C3 PRO 系列产品的安装须由专业人员按照电工法规执行。
- 2) 在干净、平稳的环境中安装UPS,避开震动、灰尘、高湿、可燃性气体、可燃性液体或腐蚀性物质环境。
- 3) UPS正常工作时的环境温度要求在0-40℃之间。如果工作在40℃以上的环境里,要求最大带载量按每增加5℃,递减12%额定值实施。UPS工作时的最高环境温度要求不超过50℃,高温环境下的长时间带载工作会影响UPS寿命。
- 4) 电池组建议在15-25℃之间使用。
- 5) UPS正常工作时的海拔要求为1000米(3300英尺)以下,如果客户使用在1000米以上,请拨打山特热线获取更多的信息。

3.2 安装空间

3C3 PRO 20KS-200KS采取的是正面风扇强制冷却,安装场地必须考虑通风问题,同时为了便于机内维护,因此也要考虑预留维护空间,安装空间参考如下:

机柜顶部	≥300mm的工作空间*
机柜前部	≥900mm的工作空间
机柜后部	≥600mm的工作空间*
机柜左侧	≥50mm的工作空间*
机柜右侧	≥50mm的工作空间*

* 60KS/80KS机型维护时需拆顶盖板,需预留≥600mm的顶部维护空间。

* 如果客户需要较小的后侧间隙要求(<600mm),应与客服联系。

* 20KS/30KS/40KS UPS维护从侧面进行,当安装空间参考上表时,请预留≥800mm的线缆,便于维护时将UPS朝前移出;或将左右侧安装空间加大,预留≥600mm的维修空间。其它机型的UPS维护从正面进行,具体安装空间参考上表。

3.3 用户功率端子位置安装图

3C3 PRO 20KS/30KS/40KS/60KS/80KS/100KS/120KS/160KS/200KS标配为双电源输入，用户可根据需要要求客服工程师现场进行单/双电源输入配置的切换，所有的安装需由本公司或经本公司授权的技术人员进行操作，请勿擅自打开机箱盖，否则会有触电的危险。

3C3 PRO 20KS/30KS接线方式：

1.用户功率端子位置安装图：

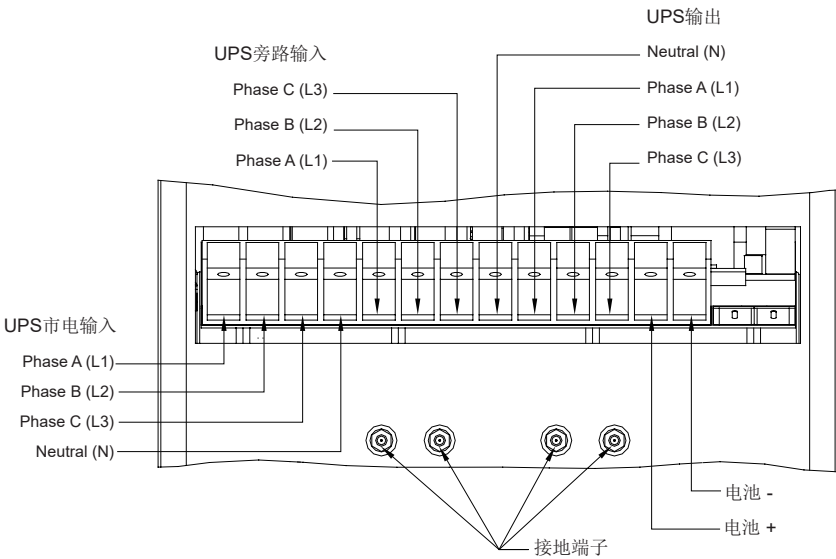

3C3 PRO 40KS接线方式:

1.用户功率端子位置安装图:

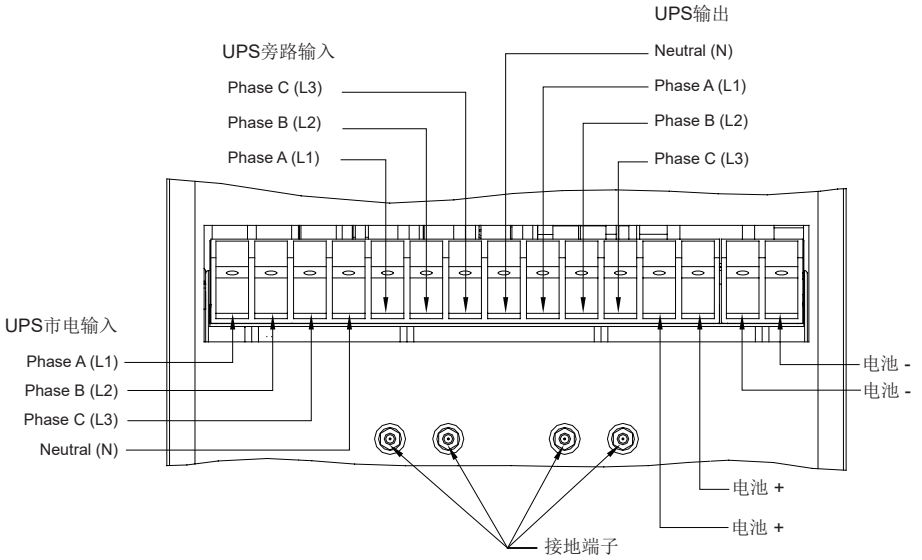

3C3 PRO 60KS/80KS接线方式:

2.用户功率端子端子位置安装图:

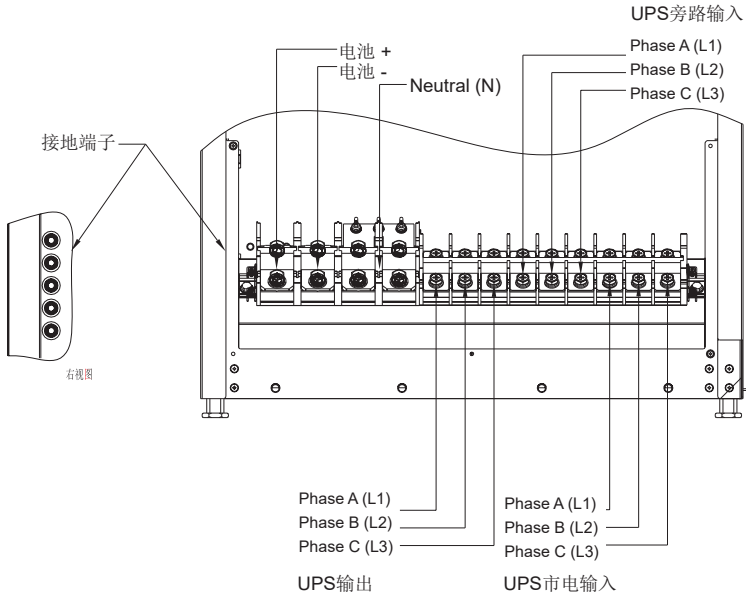

3C3 PRO 100KS/120KS接线方式:

3.用户功率端子端子位置安装图:

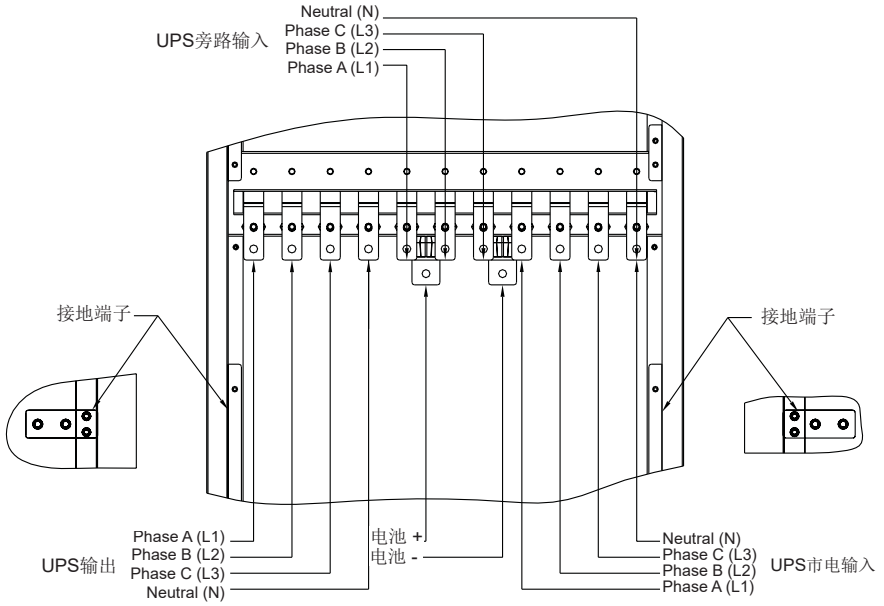

3C3 PRO 160KS/200KS接线方式:

4.用户功率端子位置安装图:

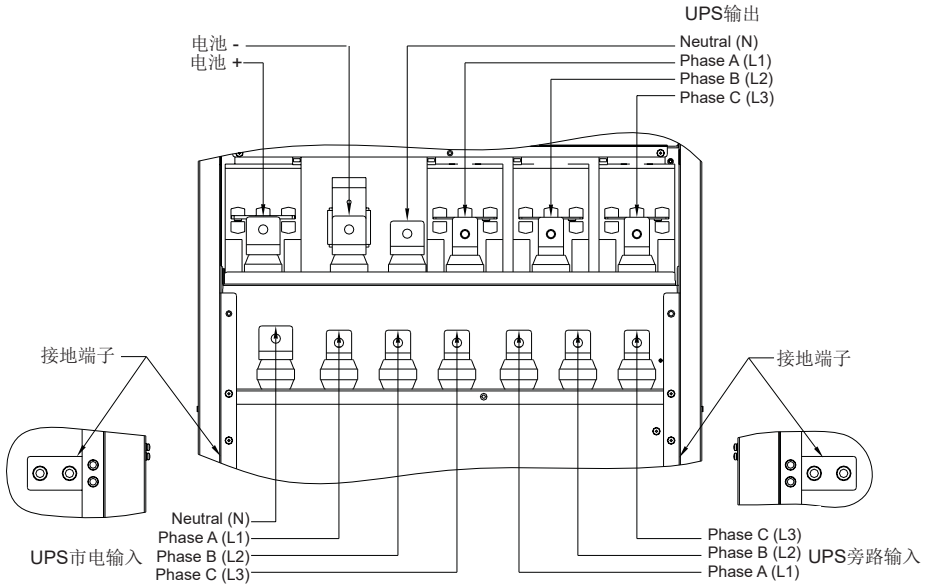

注意事项:

- 请务必确认输入电源为3相4线，电源电压在允许的输入电压范围内（见附录一）；
- 输入电源需为正相序，电池极性切勿接错；

3.4 3C3 PRO 系列UPS配线表和保护装置

3C3 PRO系列UPS外接电池要求是串联连接正负各一组相同容量的电池组（12V每节）。20-80kVA, 28-36节,默认32节，标称电压为336V-432V；100-200kVA, 36-40节，默认40节，标称电压为432V-480V。您可根据实际需要选择电池的容量和组数。电池组必须要配置电池直流开关和输入保险，电力线径也需考虑过载以及电网电压的因素进行选择，下表供用户参考：

额定容量	横断面积 参考IEC 62040-1	单 位					
		kVA	20	30	40	60	80
		kW	18	27	36	54	72
输入/输出电压		Volts	400/400	400/400	400/400	400/400	400/400
AC输入满载电流 (3相, 1根中线, 1根 地线)		Amps	31	46	61	92	122
导线规格 (A/B/C/N线规格)	min	mm ²	6×1	6×1	16×1	16×1	25×1
	max	mm ²	10×1	25×1	25×1	50×1	70×1
旁路输入满载电流 (3相, 1根中线, 1根 地线)		Amps	29	43	58	87	116
导线规格 (A/B/C/N线规格)	min	mm ²	6×1	6×1	16×1	16×1	25×1
	max	mm ²	10×1	25×1	25×1	50×1	70×1
DC输入电流 (32节电池) (1根正极线, 1根负 极线)		Total Amps	46	69	92	151	202
电池线规格 (正极和负极)	min	mm ²	6×1	10×1	16×1	35×1	50×1
	max	mm ²	25×1	35×1	50×1	50×2	70×2
AC输出电流 (3相, 1根中线, 1根 地线)		Amps	29	43	58	87	116
输出线规格 (A/B/C/N线规格)	min	mm ²	6×1	6×1	16×1	16×1	25×1
	max	mm ²	10×1	25×1	25×1	50×1	70×1
接地			1.0倍				
中线 (N)			1.7倍				

额定容量	横断面积 参考IEC 62040-1	单位				
		kVA kW	100 90	120 108	160 144	200 180
输入/输出电压		Volts	400/400	400/400	400/400	400/400
AC输入满载电流 (3相, 1根中线, 1根地线)		Amps	154	187	248	309
导线规格 (A\B\C\N线规格)	min	mm ²	35×1	50×1	70×1	95×1
	max	mm ²	95×1	120×1	150×1	240×1
旁路输入满载电流 (3相, 1根中线, 1根地线)		Amps	144	173	231	298
导线规格 (A\B\C\N线规格)	min	mm ²	35×1	50×1	70×1	95×1
	max	mm ²	95×1	120×1	150×1	240×1
DC输入电流 (40节电池) (1根正极线, 1根负极线)		Total Amps	206	247	330	412
电池线规格 (正极和负极)	min	mm ²	50×1	70×1	185×1	300×1
	max	mm ²	120×1	150×1	400×2	400×2
AC输出满载电流 (3相, 1根中线, 1根地线)		Amps	144	173	231	289
输出线规格 (A\B\C\N线规格)	min	mm ²	35×1	50×1	70×1	95×1
	max	mm ²	95×1	120×1	150×1	240×1
接地			1.0倍			
中线 (N)			1.7倍			

备注:

1. 客户端在连接UPS前必须在配电系统中安装额定规格值的三极过流断路保护装置, 断开所有的相线, N线开关可单独配用;
2. 在单相电流超过100A时, 所用保护空气开关必须带有灭弧装置, 客户端建议是选用UL认证的D曲线空开;
3. 电池正/负线径: 表示UPS与电池箱配线线径, 正极为红色线, 负极为黑色线;
4. 电池线(正、负、)必须长度相同, 建议不要超过40m。

3C3 PRO 20KS\30KS\40KS UPS外部电源接线端子

端子功能	端子	功能	接线端子的尺寸	拧紧扭力 Nm (lb in)	螺栓规格
市电输入到整流	L1	Phase A	M6 bolt mounting	5 (44)	28.26 mm ² (M6).
	L2	Phase B	M6 bolt mounting	5 (44)	28.26 mm ² (M6)
	L3	Phase C	M6 bolt mounting	5 (44)	28.26 mm ² (M6)
	N	Neutral	M6 bolt mounting	5 (44)	28.26 mm ² (M6)
市电输入到旁路	L1	Phase A	M6 bolt mounting	5 (44)	28.26 mm ² (M6)
	L2	Phase B	M6 bolt mounting	5 (44)	28.26 mm ² (M6)
	L3	Phase C	M6 bolt mounting	5 (44)	28.26 mm ² (M6)
	N	Neutral	M6 bolt mounting	5 (44)	28.26 mm ² (M6)
UPS输出到负载	L1	Phase A	M6 bolt mounting	5 (44)	28.26 mm ² (M6)
	L2	Phase B	M6 bolt mounting	5 (44)	28.26 mm ² (M6)
	L3	Phase C	M6 bolt mounting	5 (44)	28.26 mm ² (M6)
	N	Neutral	M6 bolt mounting	5 (44)	28.26 mm ² (M6)
直流输入	+	Battery (+)	M6 bolt mounting	5 (44)	28.26 mm ² (M6)
	-	Battery (-)	M6 bolt mounting	5 (44)	28.26 mm ² (M6)
用户接地	Ground		M6 bolt mounting	5 (44)	28.26 mm ² (M6)

3C3 PRO 60KS\80KS UPS外部电源接线端子

端子功能	端子	功能	接线端子的尺寸	拧紧扭力 Nm (lb in)	螺栓规格
市电输入到 整流	L1	Phase A	M8 bolt mounting	15 (133)	50.24 mm ² (M8)
	L2	Phase B	M8 bolt mounting	15 (133)	50.24 mm ² (M8)
	L3	Phase C	M8 bolt mounting	15 (133)	50.24 mm ² (M8)
	N	Neutral	M10 bolt mounting	24 (213)	78.5 mm ² (M8)
市电输入到 旁路	L1	Phase A	M8 bolt mounting	15 (133)	50.24 mm ² (M8)
	L2	Phase B	M8 bolt mounting	15 (133)	50.24 mm ² (M8)
	L3	Phase C	M8 bolt mounting	15 (133)	50.24 mm ² (M8)
	N	Neutral	M10 bolt mounting	24 (213)	78.5 mm ² (M8)
UPS输出到 负载	L1	Phase A	M8 bolt mounting	15 (133)	50.24 mm ² (M8)
	L2	Phase B	M8 bolt mounting	15 (133)	50.24 mm ² (M8)
	L3	Phase C	M8 bolt mounting	15 (133)	50.24 mm ² (M8)
	N	Neutral	M10 bolt mounting	24 (213)	78.5 mm ² (M8)
直流输入	+	Battery (+)	M10 bolt mounting	24 (213)	78.5 mm ² (M8)
	-	Battery (-)	M10 bolt mounting	24 (213)	78.5 mm ² (M8)
用户接地	Ground		M8 bolt mounting	15 (133)	50.24 mm ² (M8)

3C3 PRO 160KS/200KS UPS外部电源接线端子

端子功能	端子	功能	接线端子的尺寸	拧紧扭力 Nm (lb in)	螺栓规格
市电输入到 整流	L1	Phase A	M10 bolt mounting	24 (212)	78.540 mm ² (M10)
	L2	Phase B	M10 bolt mounting	24 (212)	78.540 mm ² (M10)
	L3	Phase C	M10 bolt mounting	24 (212)	78.540 mm ² (M10)
	N	Neutral	M10 bolt mounting	24 (212)	78.540 mm ² (M10)
市电输入到 旁路	L1	Phase A	M10 bolt mounting	24 (212)	78.540 mm ² (M10)
	L2	Phase B	M10 bolt mounting	24 (212)	78.540 mm ² (M10)
	L3	Phase C	M10 bolt mounting	24 (212)	78.540 mm ² (M10)
	N	Neutral	M10 bolt mounting	24 (212)	78.540 mm ² (M10)
UPS输出到 负载	L1	Phase A	M10 bolt mounting	24 (212)	78.540 mm ² (M10)
	L2	Phase B	M10 bolt mounting	24 (212)	78.540 mm ² (M10)
	L3	Phase C	M10 bolt mounting	24 (212)	78.540 mm ² (M10)
	N	Neutral	M10 bolt mounting	24 (212)	78.540 mm ² (M10)
直流输入	+	Battery (+)	M10 bolt mounting	24 (212)	78.540 mm ² (M10)
	-	Battery (-)	M10 bolt mounting	24 (212)	78.540 mm ² (M10)
用户接地	Ground		M10 bolt mounting	24 (212)	78.540 mm ² (M10)

推荐的输入断路器与输出断路器额定值

UPS 型号	额定值	
	负载降额	400Vac
3C3 PRO-20	80% 降额	38A
	100% 额定	31A
3C3 PRO-30	80% 降额	57A
	100% 额定	46A
3C3 PRO-40	80% 降额	77A
	100% 额定	61A
3C3 PRO-60	80% 降额	115A
	100% 额定	92A
3C3 PRO-80	80% 降额	153A
	100% 额定	123A
3C3 PRO-100	80% 降额	192A
	100% 额定	154A
3C3 PRO-120	80% 降额	234A
	100% 额定	187A
3C3 PRO-160	80% 降额	310A
	100% 额定	248A
3C3 PRO-200	80% 降额	386A
	100% 额定	309A

推荐的旁路断路器与旁路保险丝额定值

UPS 型号	断路器		保险丝参数	
	额定电压/min 400Vac		额定电压/min 400Vac	
	额定电流	脱扣特性	电流/Min	I2T/Max
3C3 PRO-20	40A	C或D	40A	10200A ² Sec
3C3 PRO-30	63A	C或D	63A	10200A ² Sec
3C3 PRO-40	80A	C或D	80A	20400A ² Sec
3C3 PRO-60	125A	C或D	125A	72500A ² Sec
3C3 PRO-80	160A	C或D	160A	72500A ² Sec
3C3 PRO-100	200A	C或D	200A	202500A ² Sec
3C3 PRO-120	250A	C或D	250A	202500A ² Sec
3C3 PRO-160	300A	C或D	300A	225000A ² Sec
3C3 PRO-200	400A	C或D	400A	225000A ² Sec

推荐的直流断路器额定值

UPS 型号	额定电压/min	500Vdc	600Vdc
	负载降额	电流 (32节)	电流 (40节)
3C3 PRO-20	80% 降额	63A	NA
	100% 额定	50A	NA
3C3 PRO-30	80% 降额	95A	NA
	100% 额定	76A	NA
3C3 PRO-40	80% 降额	126A	NA
	100% 额定	101A	NA
3C3 PRO-60	80% 降额	189A	NA
	100% 额定	151A	NA
3C3 PRO-80	80% 降额	252A	NA
	100% 额定	202A	NA
3C3 PRO-100	80% 降额	NA	257A
	100% 额定	NA	206A
3C3 PRO-120	80% 降额	NA	309A
	100% 额定	NA	247A
3C3 PRO-160	80% 降额	NA	412A
	100% 额定	NA	330A
3C3 PRO-200	80% 降额	NA	515A
	100% 额定	NA	412A

3.5 并机安装

3C3 PRO 系列UPS具有直接并联功能，只需用并机线（选购件）连接可以进行2至4台UPS并联，来实现扩容或功率冗余（N+X）。机器间距保持在10cm以上，每台UPS输入之配线请遵循单机之配线要求。各台UPS的输入/输出须接自同一个输入/输出接线盘，然后由接线盘配线去负载，见下图示：

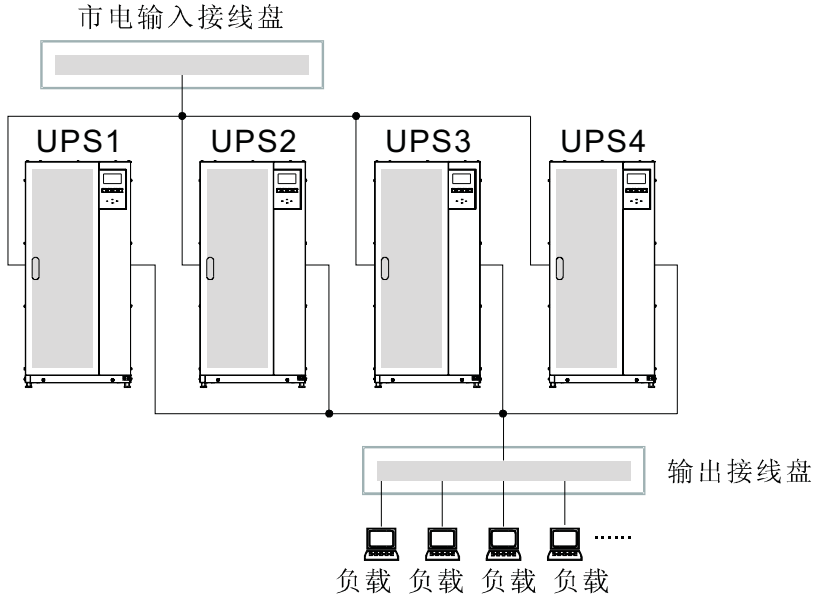

注：

1. 20-80K支持两台并机共用电池组；每组电池必须采用同一厂家同一型号同一批次的产品；
2. 输入输出配线长度要求：
 - ① 当每台UPS的输入（输出）端至输入（输出）接线盘间的引线长小于20米时，要求各线长差小于20%；
 - ② 当每台UPS的输入（输出）端至输入（输出）接线盘间的引线长大于20米时，要求各线长差小于10%。

3.并机接线图:

3C3 PRO 20KS/30KS/40KS机种

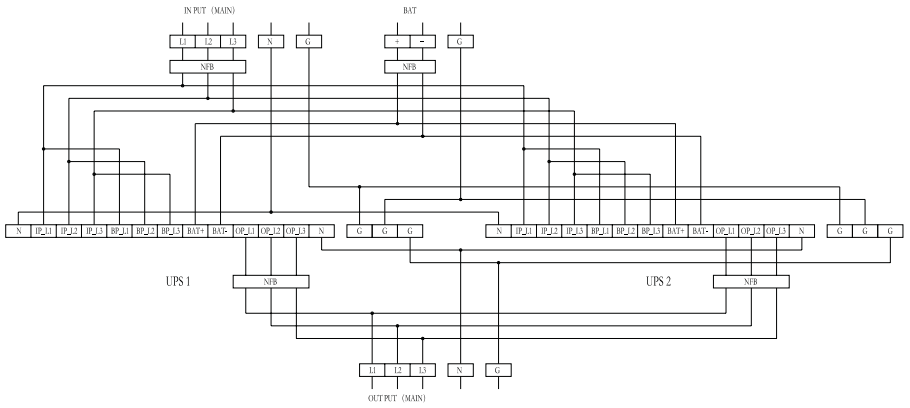

3C3 PRO 60KS/80KS机种

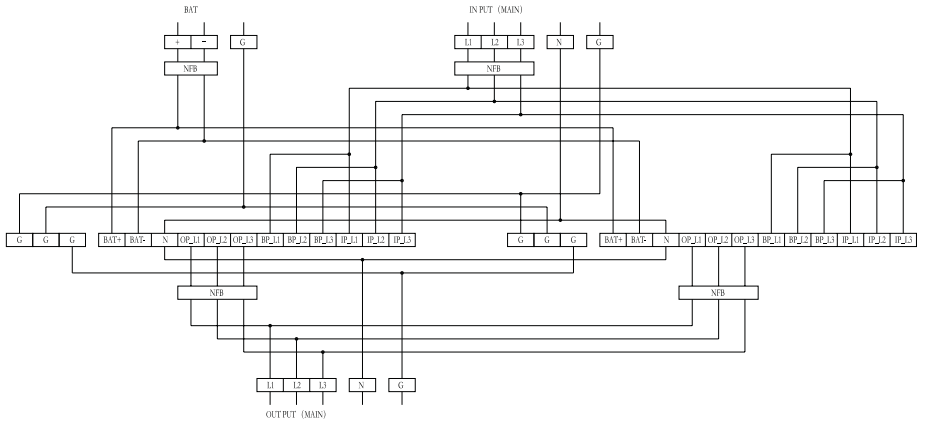

3C3 PRO 100KS/120KS机种

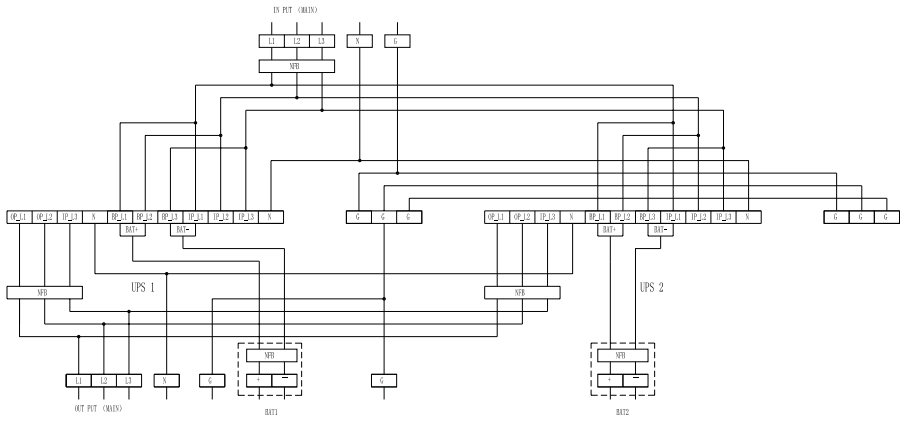

3C3 PRO 160KS/200KS机种

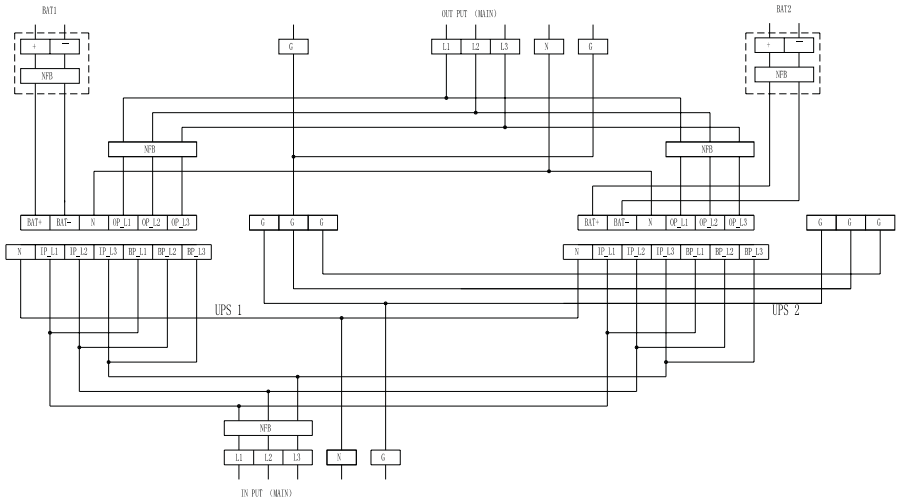

3.6 电池箱连接UPS的步骤

电池箱与UPS之间务必安装额定规格值的过流保护断路器，具体规格可见上一节的配线表。

1. 确保UPS的输入输出端均不带电，外接电池插座无电压输出；
2. 将电池箱开关置于“OFF”状态；
3. 先将UPS的端子排盖板打开，然后将UPS端子排引出的电池+、一线对应连接到电池箱上的+、一线，切勿将电池正负极接反；
4. 用万用表（直流电压档）量测正负电池的电压以及电压正负，确保正负极连接正确，合上端子排盖板。

注：电池的连接与更换应在系统关机状态下进行，严禁带电以及非专业人士的操作，否则会有电击危险。

第4章 操作

4.1 单机操作

1. 确定A、B、C 电源相序连接正确，然后送电到UPS。
2. 合上电池箱上的开关 (请确定UPS端子排+、-与电池箱+、-极一一对应)。
3. 合上UPS上的“输入开关”（市电输入开关），此时风扇转动进行UPS自检，约4 秒则自动进入主菜单，然后依下列液晶显示操作。

注：以3C3 PRO 80KS为例，以下图中数据为参考值。

1)合上UPS 的“输入开关”后，机器自测后， 2) 进入主菜单页面
若15S内没有按键操作,进入主菜单页面。

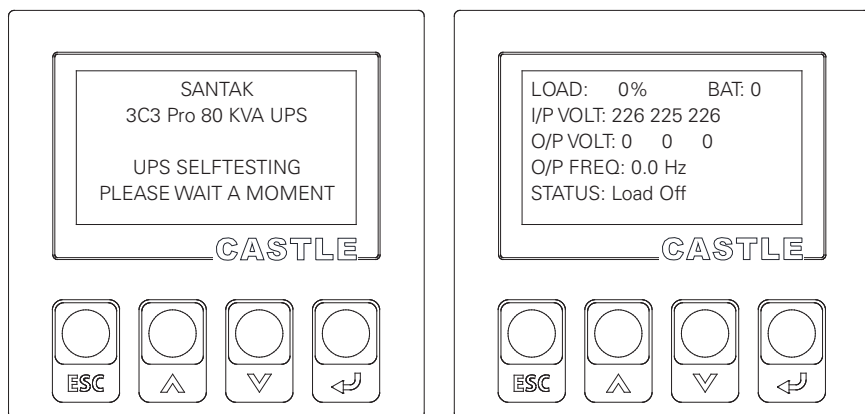

3)再按下▼键可以得到以下资料

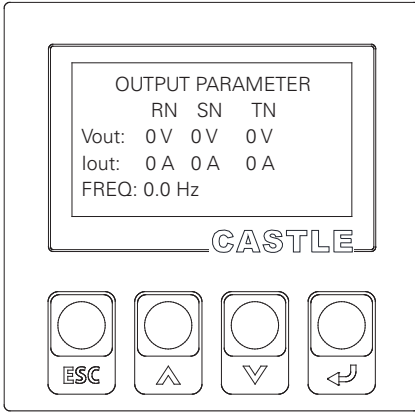

4)再按下▼键可以得到以下资料

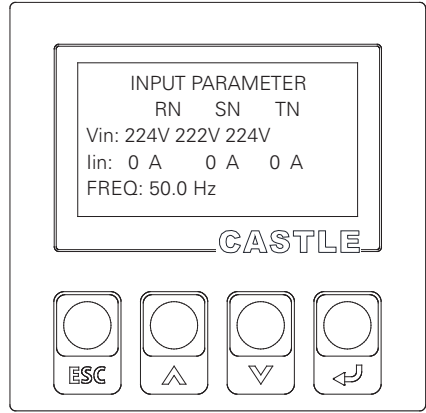

5)再按下▼键可以得到以下资料

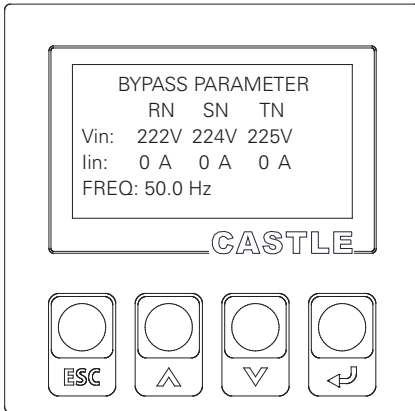

6)再按下▼键可以得到以下资料

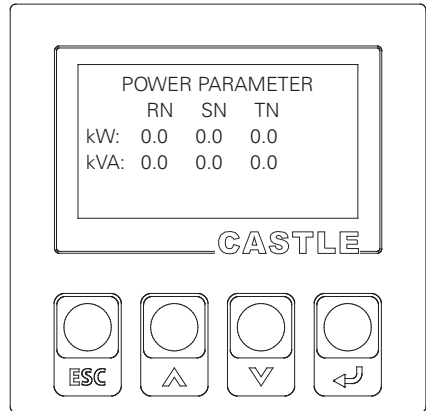

7)再按下▼键可以得到以下资料

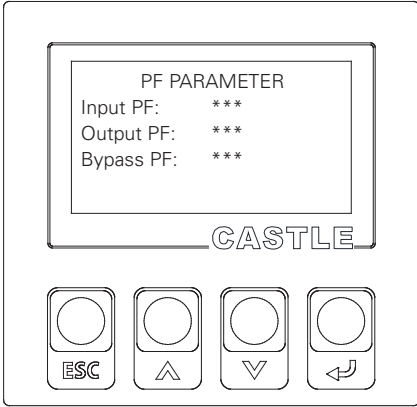

8)再按下▼键可以得到以下资料

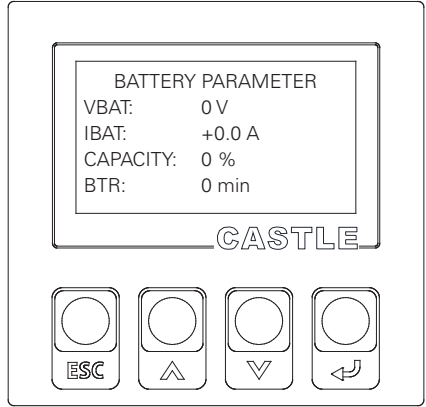

9)再按下▼键可以得到以下资料

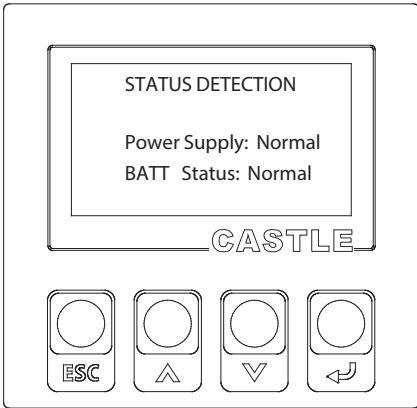

10)再按下▼键可以得到以下资料

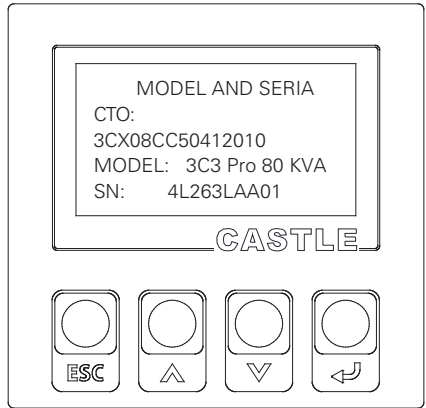

11)再按下▼键可以得到以下资料

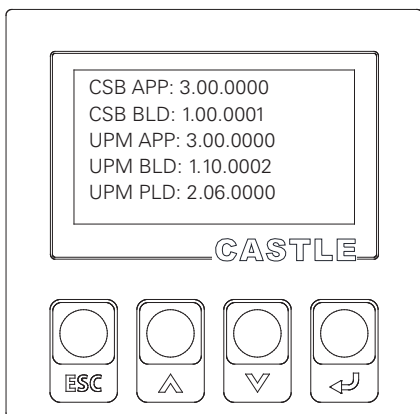

12)再按下▼键可以得到以下资料

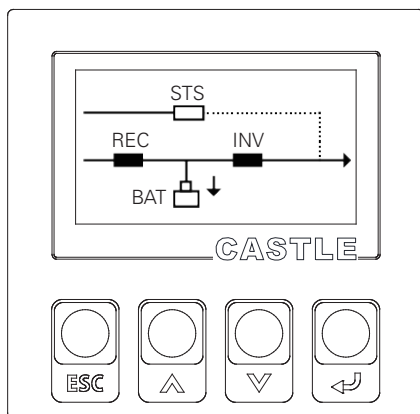

4. 开机与关机动作

1) 进入控制界面

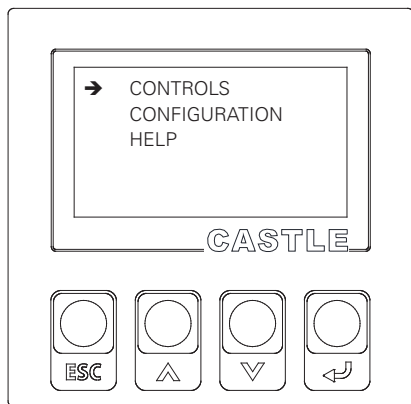

2) 按下ENTER键

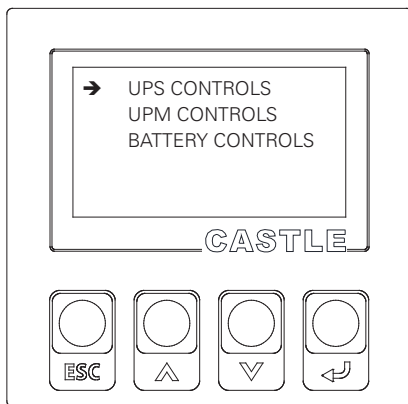

3) 选择开机

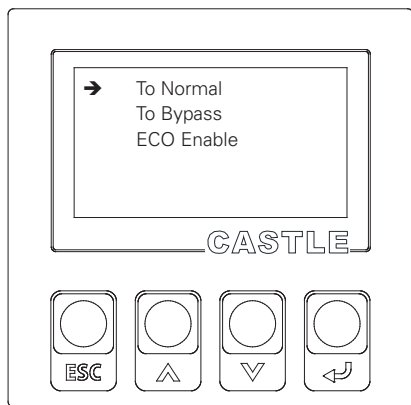

4) 输入密码进行开机进入主页面

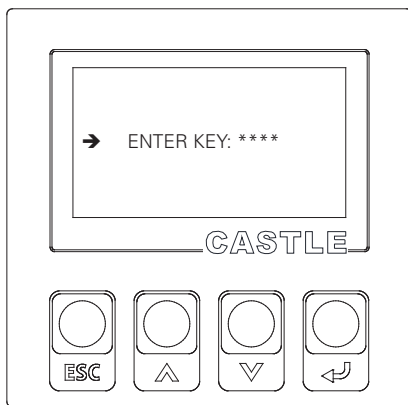

5)选择系统关机

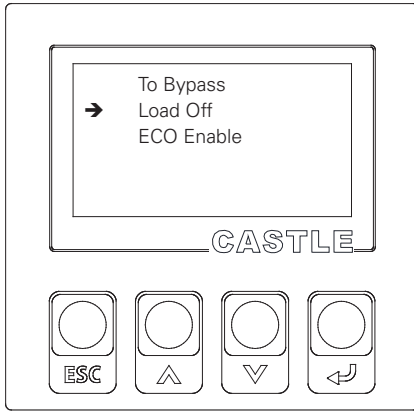

6)确认系统关机

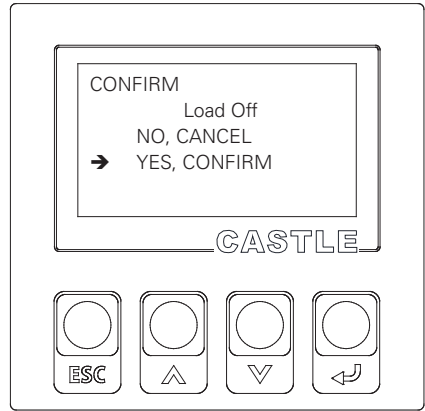

3C3 PRO系列UPS可在无市电输入状态下直流开机工作，面板相似于市电开机的画面，按照画面提示可执行直流开机：

- ①. 在UPS旁路模式下，预先将直流开机功能开启
- ②. 确认电池正、负、N线与UPS均正确连接
- ③. 合上电池开关
- ④. 轻触ENTER键
- ⑤. 在LCD完成自检后40秒内手动执行开机命令

5. 设定页面，可以通过机器的开机密码，进入设定画面，进行以下程序的设定。

1)按下翻键选择设定按键

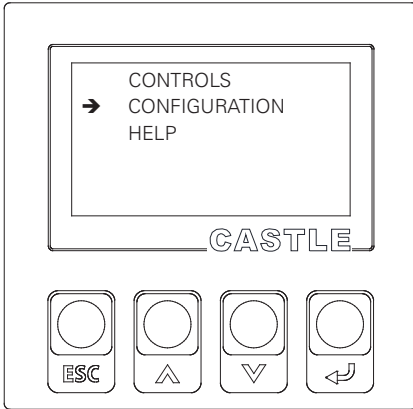

2)用户/维护密码输入页面
进入用户设定页面；
成功输入维护人员密码，
进入维护人员设定页面。

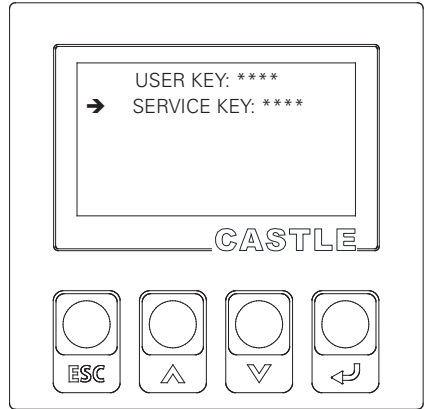

3)用户设定页面

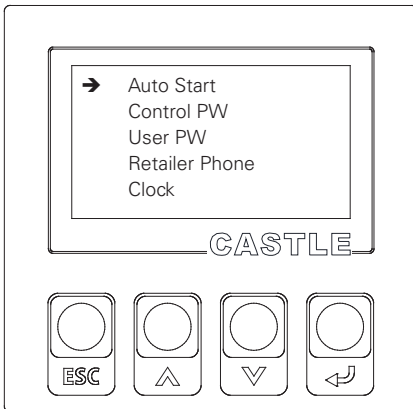

4)经销商电话设定界面

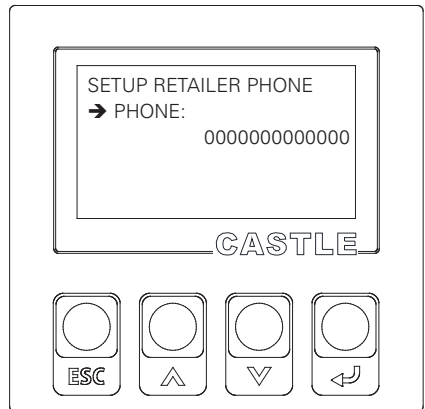

6. 查询动作

1) 可以通过机器的开机密码，进入查询界面

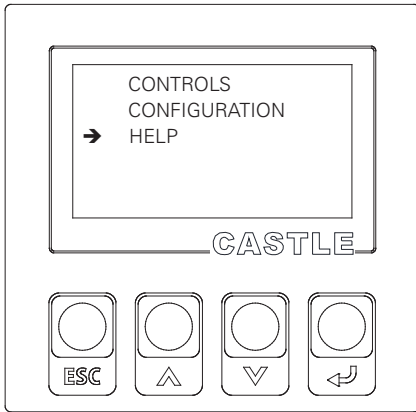

2) 查询页面

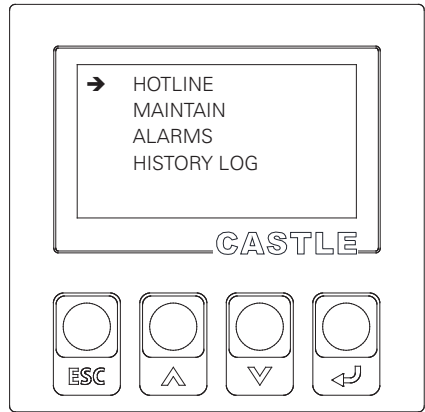

3) 服务热线与经销商电话查询界面

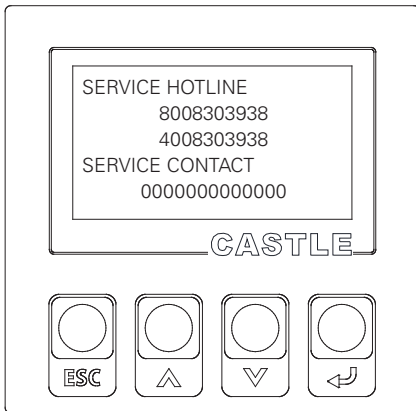

4.2 并机操作

1)成功输入用户密码或维护人员密码

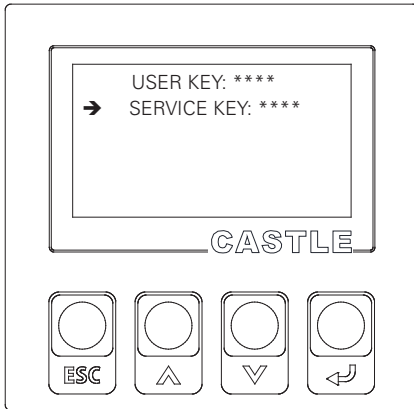

2)进入并机设定界面

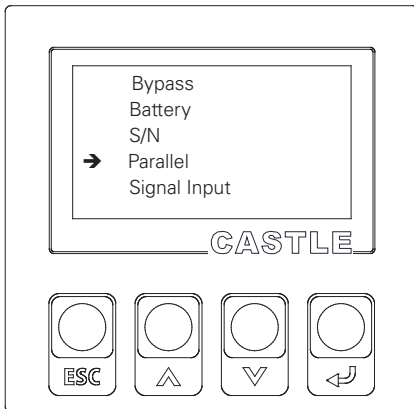

3)并机参数设定界面

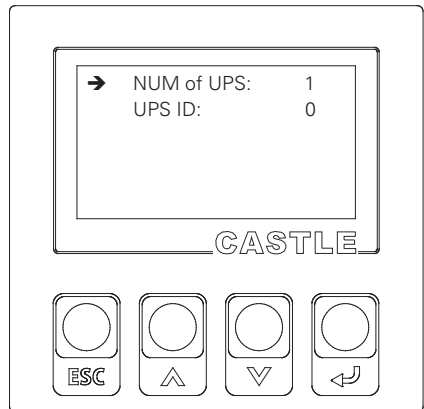

第5章 通讯界面

3C3 PRO系列UPS提供了扩展插槽、并机接口(RJ45)、REPO及本公司或本公司授权的技术人员专用的SERVICE监控通讯接口。

3C3 PRO 20KS/30KS/40KS

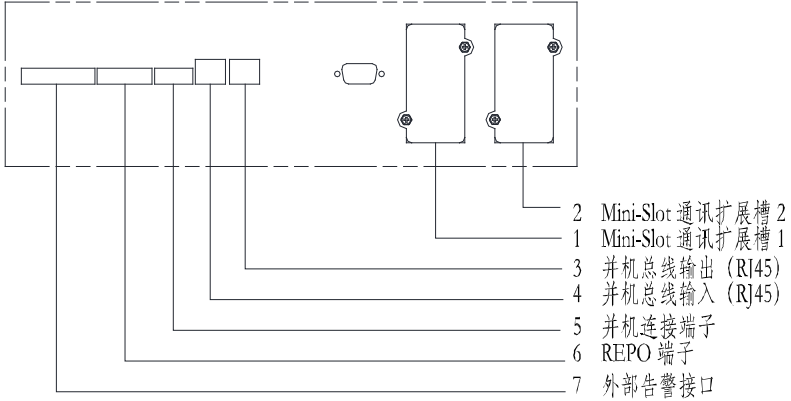

3C3 PRO 60KS/80KS

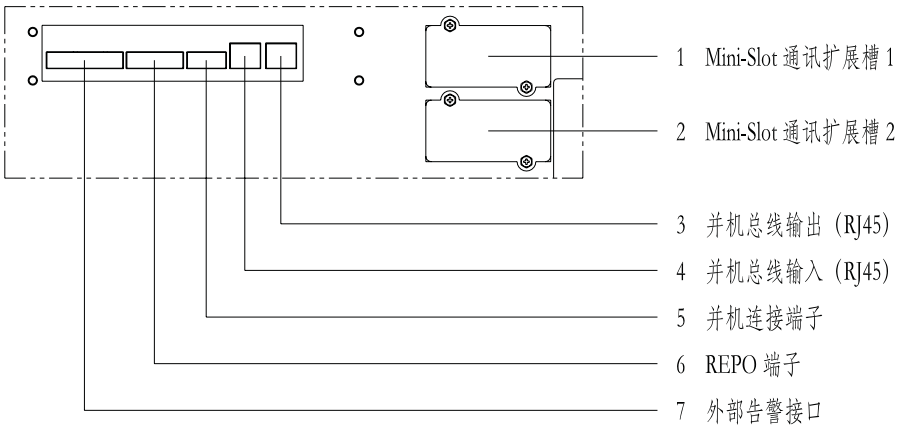

3C3 PRO 100KS/120KS

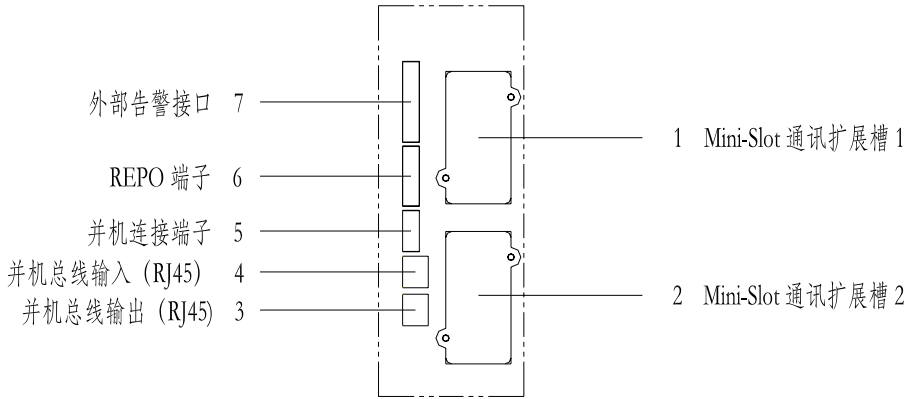

3C3 PRO 160KS/200KS

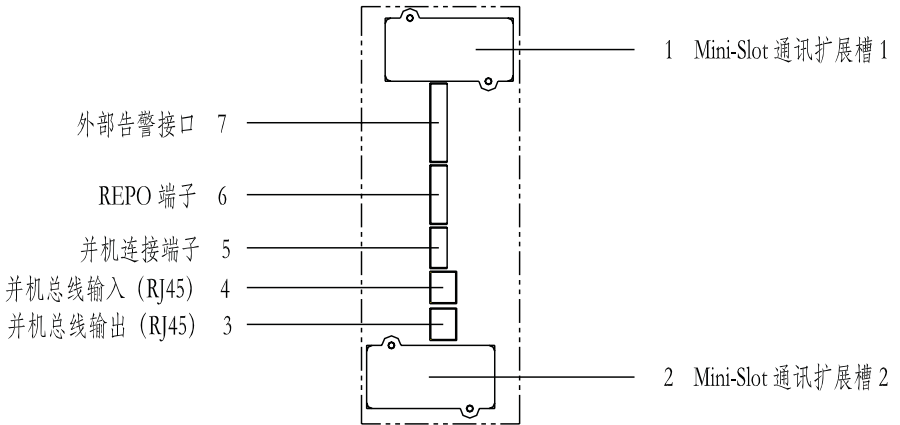

1 (2) . 扩展插槽：20KS-200K单独配有的插槽，只提供给特殊需求用户，不对标配用户开放。

3. 并机接口(RJ45)：并机总线输出。并机使用时，并机通讯线接，20KS-200KS可实现4台并机。

4. 并机接口(RJ45): 并机总线输入。

5. 并机连接端子: 检查并确保UPS系统关闭, 参照并机接线图连接好并机系统。

6. REPO: 紧急关机开关, 提供有紧急关机需求用户, 可以直接通过此开关关闭UPS输出。

7. 外部告警接口: 此标准功能可用于将外部告警信号连接到UPS相应的接口端子上, 如烟雾告警器或过热告警信号。外部告警装置与UPS接口端子之间应该用一对双绞线连接。通过LCD可以为每个接口端子选择不同的外部告警功能(名称)。

上述通讯接口的使用问题, 请拨打山特400-830-3938或800-830-3938客服服务热线咨询。

并机连接端子:

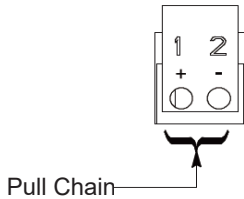

1. Pull Chain+

2. Pull Chain-

输出: 并机系统的备份控制信号

REPO外部接线图说明:

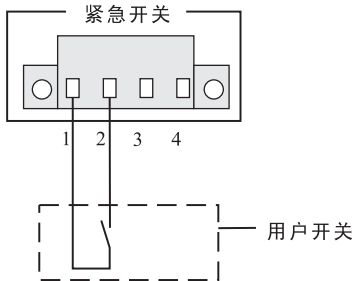

1-2闭合时, UPS执行紧急关机。3-4闲置。

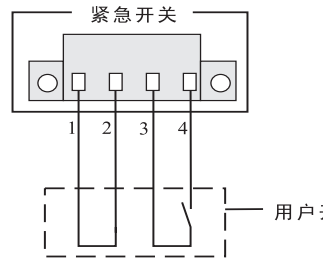

1-2用短线连接, 使其一直处于连接状
3-4打开时, UPS执行紧急关机。

并机接线图说明：

注意事项：

并机系统中，每台UPS的输入到交流配电电源公共点的电力线长度及输出到负载公共点的电力线长度应该一致，其长度应符合下面规则以保证每台UPS的输入以及输出阻抗匹配，阻抗误差在±10%以内。这是为了达到并联UPS的均流效果。建议并机系统输入和输出电缆长度大于10米.输入输出各5米。

总长度 1A=2A=3A=4A

1B=2B=3B=4B

1C=2C=3C=4C

如果仅仅是2台UPS并联（冗余），以上要求是非必须的，但是会影响后续的扩容。

确保并机系统中每台UPS的静态旁路输入是同一公共点，如同一个外部旁路断路器。如果并机系统中各台UPS的整流输入是独立的配电电源，请咨询山特工程师确保配电兼容性。

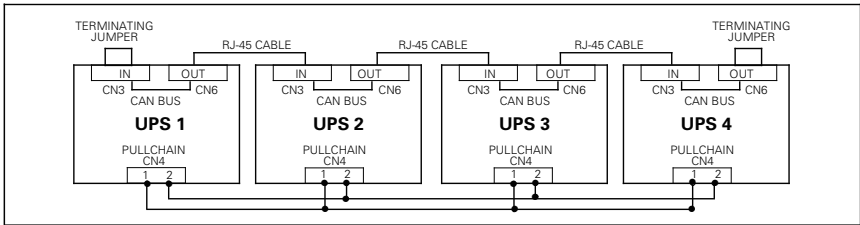

并机线接线图-不带并机柜

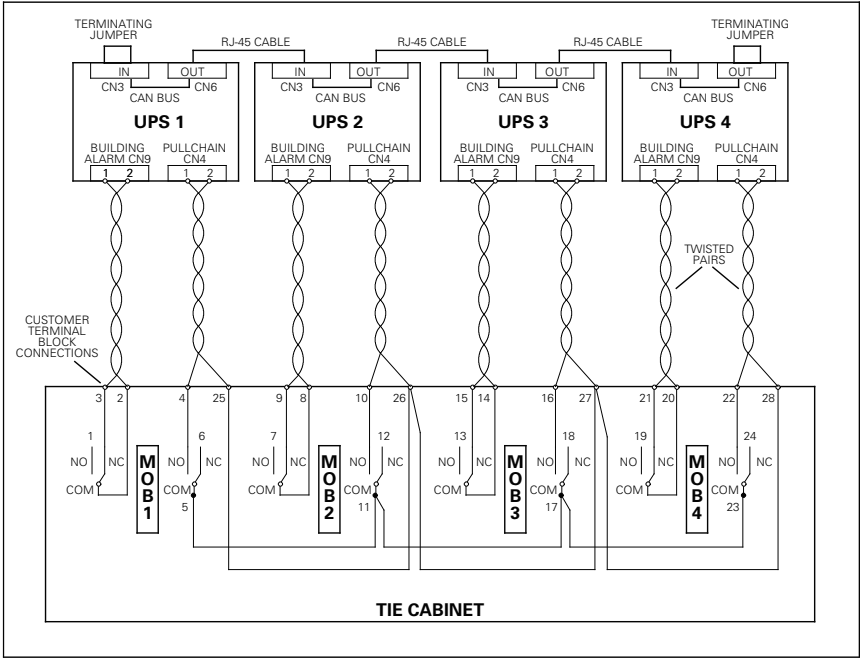

并机线接线图-带并机柜

第6章 选配件介绍

6.1 防尘过滤网

防尘网是3C3 PRO系列产品针对灰尘恶劣的环境（直径1.0mm的异物，特别是金属和类金属型）设计的选配件，使UPS防尘能力有效提升，安装方便，易更换和清洗。

3C3 PRO 20-40KS防尘网示意图:

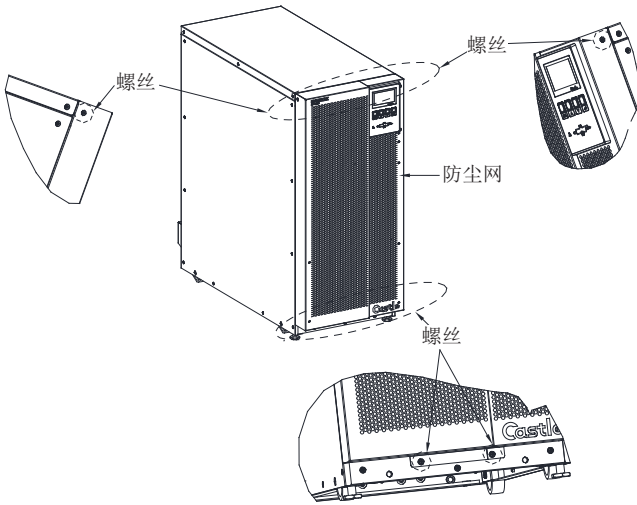

3C3 PRO 60-200KS防尘网示意图:

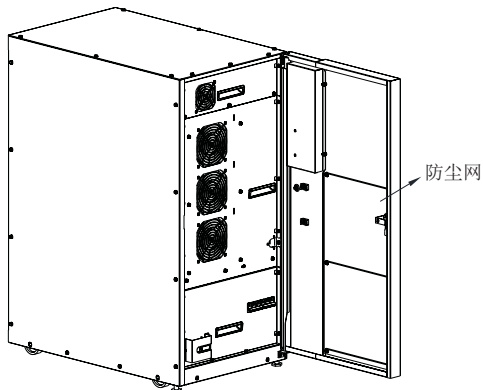

6.2 温度传感器

电池为低寿命器件且对温度相对敏感，温度传感器可以及时侦测电池温度的变化，只需在LCD显示界面开启充电电压温度补偿的功能，电池充电电压则会自动调整，从而提高电池的使用寿命。

6.3 单输入电源

3C3 PRO 系列20-80kVA型号可以根据客户需求，通过随机附送的电源跳线将标配的双电源输入改为单电源输入。

第7章 运输、维护与故障排除

搬运UPS

请遵守下列步骤进行UPS的搬运准备。

注意：由于UPS很重，需要特殊设备（如叉车）进行装卸。

1. 关闭与UPS相连的所有设备，并拆除UPS端子排的所有连接线。
2. 将UPS市电开关及电池组开关断开。

维护与保养

3C3 PRO 系列UPS只需很少的维护。

1. 如果断开电池连接，负载设备将不受停电保护。
2. 正常情况下，如果发现电池状况不佳，则必须提前更换，电池更换应由培训合格的专业人员进行，用户不得擅自处理。需注意：
 - A. 更换电池以前，需关闭UPS并脱离市电
 - B. 脱下如戒指、手表之类的金属物品
 - C. 使用带绝缘手柄的螺丝刀，请勿将工具或其他金属物放在电池上以免短路引起触电或造成电池爆炸
 - D. 请勿将电池正负极短接或反接
3. 电池不宜个别更换，整体更换时应遵守电池供应商的指示，并由经授权的专业人员完成。
4. 注意UPS 散热孔的通风顺畅，平均每隔半年清洁一次侧板和风扇的通风孔处的灰尘（清洁前请先断开市电及电池开关）。

故障排除

如果本设备需要检修，请先按以下步骤检查：

1. UPS输入配线是否正确？
2. 所有过流保护断路器是否断开？
3. 输入电压是否符合规格要求？

再参考产品使用手册中的“异常状态表”以及附录二的“灯号参照表”说明进行适当处理：

异常状态表		
问题	液晶显示或可能原因	处理方法
“故障”灯亮，间歇警报	旁路下或逆变下过载	减小负载至额定值
	市电异常	检查输入配线是否掉线、输入电压是否异常。
	电池未接	检查电池开关是否合上、电池配线是否接触良好。
“故障”灯亮，连续警报	UPS故障	
电池放电时间低于初次放电时间1/3以下	电池耗损	请与山特客服中心联络
	充电器故障	
LCD面板不显示字符		长按ESC键3秒，LCD复位。

若问题依然存在，请与山特客服中心联系：400-830-3938（手机）/800-830-3938（固话），并务必提供以下信息：

- UPS 型号、CTO 号、机器批号（S/N）；

		山特电子（深圳）有限公司			
型号：3C3 PRO-20KS 名称：不间断电源					
输入：AC380/400/415V, 3W+N+PE, 50/60Hz, 32/31/29A, lcc:10kA					
旁路：AC380/400/415V, 3W+N+PE, 50/60Hz, 30/29/28A, lcc:10kA					
输出：AC380/400/415V, 3W+N+PE, 50/60Hz, 30/29/28A, 20kVA/18kW					
电池：DC384V, 51A, lcc:10kA (详见使用手册)					
9106-52240					
MFG P/N:					
9106-52240-XX					
P/N:					
3CN02CC50412014					
CTO:		生产厂：山特电子（深圳）有限公司 地址：深圳市宝安区72区宝石路8号 伊顿电源（上海）有限公司 地址：中国（上海）自由贸易试验区日滨路76号B5部位			
4FXXLAAXX					
S/N:					

- 故障发生日期；
- 完整的问题说明（包括LCD信息、指示灯显示、蜂鸣器鸣叫情况、电力情况、负载容量等）。

附录一 技术参数

型号	3C3 PRO 20KS	3C3 PRO 30KS	3C3 PRO 40KS	3C3 PRO 60KS	3C3 PRO 80KS	
额定容量	20KVA/18KW	30KVA/27KW	40KVA/36KW	60KVA/54KW	80KVA/72KW	
输入方式	三相+零线+地线					
频率	42 - 72Hz					
功率因数	≥ 0.99					
输入	额定230/400Vac (220/380, 240/415可选) 190/330 ~ 276/478Vac (-15%, +20%), 100%负载下 116/201 ~ 276/478Vac (-50%, +20%), 50%负载下					
	旁路电压范围 额定230/400Vac (220/380, 240/415可选) 207/359 ~ 253/438Vac (默认范围额定电压±10%, 最大可选范围±20%)					
输出	额定电压 230/400Vac, 3相 + 中线 + 地线, (220/380, 240/415可选)					
	功率因数 0.9					
	频率误差 (42-72)Hz±4Hz					
效率	过载时间 40℃环温下, 102~110%负载60分钟, 111~125%负载10分钟, 126~150%负载1分钟, >151%负载150毫秒					
	双转换模式	94%				
ECO模式	98%					
使用环境	环境温度 0-40℃					
	储藏温度 -15 ~ +55℃ 保护包装完好的情况下					
	环境湿度 5 - 95 % , 无凝露					
	海拔高度 海平面1000米内无降额, 最大2000米, 1000米以上每升高100米, 降额1%					
整机及备件 1年以内运输与存储环境 (根据机器序列号标注的机器生产日期)	存储地点	室内				
	灰尘	良好				
	存储温度	< 40 °C				
	存储湿度	< 70% RH				
	其他	需要带初始包装保存				
如果机器的实际存储条件不符合上述存环境, 请根据实际存储环境重新评估存时间。						
电池标称电压/ 额定充电电压	336V (168 Cells) ~ 432V (216 Cells), 默认384V (192 Cells)					
重量	净重(不含电池)	61.5 Kg	67 Kg	93 Kg	177 Kg	184 Kg
	毛重(不含电池)	87.5 Kg	75 Kg	101 Kg	223 Kg	230 Kg
机器尺寸 (宽*深*高) (mm)	350×805×800	350×805×800	350×805×800	600×720×1200	600×720×1200	
安全标准	国家标准	GB4943				
	TLC认证	YD/T1095				
EMC	国家标准	GB/7260.2				
	国际标准	IEC/62040.2				
警告: 本产品用于第二类环境中的商业和工业用途, 可能需要采取安装限制或附加措施以抑制骚扰。						

技术参数指标					
型号	3C3 PRO 100KS	3C3 PRO 120KS	3C3 PRO 160KS	3C3 PRO 200KS	
额定容量	100KVA/90KW	120KVA/108KW	160KVA/144KW	200KVA/180KW	
输入	输入方式	三相+零线+地线			
	频率	42 - 72Hz			
	功率因数	≥ 0.99			
	市电电压范围	额定230/400Vac (220/380, 240/415可选) 190/330 ~ 276/478Vac (-15%, +20%), 100%负载下 116/201 ~ 276/478Vac (-50%, +20%), 50%负载下			
	旁路电压范围	额定230/400Vac (220/380, 240/415可选) 207/359 ~ 253/438Vac (默认范围额定电压±10%, 最大可选范围±20%)			
输出	额定电压	230/400Vac, 3相 + 中线 + 地线, (220/380, 240/415可选)			
	功率因数	0.9			
	频率误差	(42-72)Hz±4Hz			
	过载时间	40℃环温下, 102~110%负载60分钟, 111~125%负载10分钟, 126~150%负载1分钟, >151%负载150毫秒			
效率	双转换模式	94%			
	ECO模式	98%			
使用环境	环境温度	0 - 40℃			
	储藏温度	-15 ~ +55℃保护包装完好的情况下			
	环境湿度	5 - 95 %, 无凝露			
	海拔高度	海平面1000米内无降额, 最大2000米, 1000米以上每升高100米, 降额1%			
整机及备件 1年以内运 输与存储环 境(根据机 器序列号标 注的机器生 产日期)	存储地点	室内			
	灰尘	良好			
	存储温度	< 40 °C			
	存储湿度	< 70% RH			
	其他	需要带初始包装保存			
如果机器的实际存储条件不符合上述存环境, 请根据实际存储环境重新评估存时间。					
电池标称电压/ 额定充电电压	432V (216 Cells) ~ 480V (240 Cells), 默认480V (240 Cells)				
重量	净重(不含电池)	283 Kg	311 Kg	457 Kg	457 Kg
	毛重(不含电池)	351 Kg	379 Kg	525 Kg	525 Kg
机器尺寸 (宽*深*高) (mm)	600×800×1876		600×830×1876		
安全 标准	国家标准	GB4943			
	TLC认证	YD/T1095			
EMC	国家标准	GB/7260.2			
	国际标准	IEC/62040.2			
警告: 本产品用于第二类环境中的商业和工业用途, 可能需要采取安装限制或附加措施以抑制骚扰。					

非默认电池节数配置请确保您与山特销售或技术支持团队获得确认。

附录二 灯号参照表

序号	工作状态	面板指示灯显示					蜂鸣器
		旁路灯	市电灯	逆变灯	电池灯	告警灯	
1	市电模式						
	正常		●	●			
	告警		●	●		●	★
2	旁路模式						
	正常	●					
	告警	●				●	★
3	电池模式						
	正常			●	●		
	告警			●	●	●	★
4	电池ECT						
	正常	●		●	●		
	告警	●		●	●	●	★
5	市电ECT						
	正常	●	●	●			
	告警	●	●	●		●	★
6	ECO 模式						
	正常	●		●			
	告警	●		●		●	★
7	LOAD OFF						
	正常						
	告警					●	★

若有出现不包含以上的显示或警示状况，请与经销商或拨打山特服务热线咨询。

● 指示灯点亮

★ 蜂鸣器工作周期为3S ----- 响0.5S，静默2.5S。

具体故障信息可联系客服人员。

附录三 维修保证

本公司承诺：自购机之日起，为您提供三年免费保修服务。

- 凭经销商有效证明保修；
- 凭机器生产序号保修；

在保修期间造成运输费用，由用户承担。如机器发生故障，请就近与本公司服务网点及经销商联系。

作为山特用户，您享有如下服务：

- 三年保修（含从山特购买的电池）；
- 24小时服务热线（热线号码见箱体外盖警告标签）；
- 全国联合保修；
- 网上技术服务支持；
- UPS保修期内提供免费上门维修服务。

发生以下情况，不在保修范围内：

- 人为故障；
- 超出保修期限；
- 序列号更改或者丢失；
- 因不可抗拒及外来原因引起的损坏或损失；
- 未经授权许可，自行对UPS加以拆修、改装或附加其它配件而造成的故障；
- 未依UPS电气规格规定的供电条件或现场环境使用所导致的故障；
- 使电池深度放电或人为造成损坏。

Thank you for choosing SANTAK products!

Please adhere to the warnings and instructions specified in the manual and on the equipment, and keep the manual properly for future reference. Do not try to operate the equipment before reading all the safety information and operation instructions

The manual applies to the 3C3 PRO series, including:

3C3 PRO 20KS

3C3 PRO 30KS

3C3 PRO 40KS

3C3 PRO 60KS

3C3 PRO 80KS

3C3 PRO 100KS

3C3 PRO 120KS

3C3 PRO 160KS

3C3 PRO 200KS

IMPORTANT NOTICE

Supervision Code Statement

To ensure consumer rights and safe electricity application, help you purchase authentic SANTAK UPS, the following items should be heeded:

1. Make sure of  **SANTAK**[®] 山特[®]
2. SANTAK Electronics (Shenzhen) Co. Ltd. never grants authorization in any form to any company to manufacture UPS;
3. Labeled on all SANTAK is an “electronic supervision code” (“electronic supervision code” is a code of product identification advocated by SIQSAQ in order to strike at fake commodities).

Inquiry method:

Website inquiry: Access the website:www.95001111.com (Product Identification, Authentication and Tracking System) and input the supervision code;

Tel inquiry: Call 95001111 to check (you may call 010-95001111 and follow the instructions to enquire the identification);

Message inquiry: Send text message to 106695001111 (available to both China Mobile and Unicom);

Any questions, you may call the telephone number at 95001111 or log on to www.95001111.com. for further details or lodge your complaints.

Copyright Notice

SANTAK is committed to technological innovation as it continues to deliver better products and services to customers. We reserve the rights to modify and update product design, technical specifications and user manuals without further notice. Actual products may differ from pictures shown in the manual.

The latest version of the user manual is available on www.santak.com

All Rights Reserved © 2019-2023 SANTAK Electronics (Shenzhen) Co., Ltd.

Safety Instructions

General

1. Please read through the Safety Instructions carefully before you start to operate the equipment and keep the manual well for future reference.
2. Please pay attention to the warning symbols and follow the instructions in the manual during operation.
3. Do not use the equipment in direct sunlight or rain, or in humid conditions.
4. Do not install the equipment near any sources of heat, such as heating devices like electric heaters or furnaces.
5. Please make sure there is adequate space for ventilation or maintenance around the equipment. Please follow the instructions in the manual for installation.
6. For the purpose of cleaning, please use dry and non-conductive tools to wipe down the equipment.
7. In case of a fire, please use dry powder extinguishers. Liquid fire extinguishers are not allowed.
8. Please make sure the floor on which the equipment is installed is strong enough to support the weight of the equipment with battery.
9. Please make sure the total wattage requirements of the loads do not exceed the power rating of your UPS or the capacity of the battery.

Prohibited Activities

1. Having service personnel without authorization from SANTAK to open the UPS cabinet, which contains lethal voltages is not allowed. Unauthorized opening may cause an unsafe condition, and will void the warranty.
2. Applying the following types of loads, the application, configuration, management and maintenance of which may be subject to special requirements, please inquire from dealers or SANTAK in advance:
 - A. High-precision industrial, scientific-research or medical instruments;
 - B. Facilities of which malfunctions may lead to life-threatening situations, such as elevator;

C. Loads with large inrush current and negative power consumption;

3. Exposing batteries to fire, which may cause explosions.

Electrical Safety

1. Please make sure that the grounding is firmly connected and the wiring and battery polarity are correctly connected.
2. Battery protection devices must be configured with a suitable over-current circuit breaker.
3. Before you remove your UPS or reconnect the wiring, please shut down your UPS and disconnect the air circuit breaker and the battery to ensure that the output terminals do not carry live voltage which may cause an electric shock.
4. To ensure safety and the best performance of your UPS, please choose from accessories recommended by SANTAK.
5. A proper four-pole over-current circuit breaker shall be installed before connecting clients to your UPS to prevent electric shock by disconnecting all the input wiring.

Battery Safety

1. The service life of a battery is shortened as the ambient temperature rises. Regular battery replacement ensures that your UPS work well and provides sufficient back-up time.
2. Battery replacement and maintenance must be performed by authorized personnel with professional knowledge in battery. Please replace an equivalent number of batteries of the same type and model.
3. There are risks of electric shock and short circuit with the battery. Please observe the following rules while replacing the battery to reduce the risks of electric shock:
 - A. Do not wear watches, rings or any other metallic objects;
 - B. Use insulated tools;
 - C. Wear rubber shoes and gloves;
 - D. Do not place metal tools or any other metallic accessories on the battery;

E. Disconnect the loads connected to the battery before removing terminals from the battery.

4. Do not expose the battery to fire to avoid the risks of explosion that may result in personal injury.
5. Non- professionals shall not open or disassemble the battery as electrolytes in the battery contain strong acid and other dangerous substances which may cause damage to skin and eyes. Please clean with water immediately and seek medical assistance if the electrolytes come in contact with human skin.
6. Do not connect the battery positive and negative poles as it may cause short circuit. Over current protection device is needed to avoid risks of burns or electric shock.

Maintenance

1. The working environment and storage method of UPS can affect its service life and reliability. Do not use your UPS in any of the following environments where:
 - A. the temperature and humidity are outside the required ranges, i.e.0-40° C and 0-95% humidity;
 - B. your UPS is at high risks of vibration and collision;
 - C. there are metal shavings, corrosive materials, salt and flammable gases.
2. If you plan to leave your UPS idle for a long time, please store it in dry conditions with an ambient temperature ranging between -25-55° C. Before you start up your UPS, please keep it in an environment where the ambient temperature is at or above 0° C for 2 hours or longer.
3. Keep the air inlets and outlets clear for proper ventilation. Poor ventilation will cause the temperature inside your UPS to rise, shortening the service life of the components and that of your UPS.
4. The battery should be charged at least once every three months if it is left idle and stored in an environment with a room temperature, or at least once every two months if left idle in a high temperature environment; each charge should take more than10 hours; do not discharge with no loads connected or discharge for more than 14 hours continuously.

目录

Chapter 1 Introduction	1
1.1 Introduction.....	1
1.2 Frequently used symbols.....	2
Chapter 2 Appearance Description.....	3
2.1 Unpacking and Inspection	3
2.2 UPS Cabinet Dimensions.....	4
2.3 LCD Panel Instructions.....	12
Chapter 3 Installation Instructions	13
3.1 Installation Notice	13
3.2 Required Clearance for Installation	13
3.3 Terminals	14
3.4 Wiring requirements and protective devices for 3C3 PRO series..	19
3.5 Parallel Installation	27
3.6 Steps of connecting battery cabinets to UPS	30
Chapter 4 Operation.....	31
4.1 Operations of Single UPS.....	31
4.2 Operations of UPS in Parallel Connection.....	39
Chapter 5 Communications Interface	40
Chapter 6 Optional Accessories	45
6.1 Dustproof Filter	45
6.2 Temperature Sensor	46
6.3 Dual Power Input.....	46
Chapter 7 Transportation, Maintenance and Troubleshooting	47
Appendix I Specifications	50
Appendix II Reference Table of LED Indicators.....	54
Appendix III Warranty	55

Chapter 1 Introduction

1.1 Introduction

The 3C3 PRO series are high-efficiency pure online UPS products with excellent performance that provide double conversion, and three-phase input and output. With perfect power source protection solutions, the 3C3 PRO effectively address multiple power source problems such as power outage, high-voltage AC and low voltage AC, voltage sag, damped oscillation, high voltage impulse, voltage surge, harmonic distortion, clutter interference and frequency variation, the 3C3 PRO series is widely applied for computers, communications devices and other controlling devices safely. You can choose our optional accessories to enhance your UPS in order to cope with inrush load situations in complicated industrial environment. For the governments and a range of industries including telecommunications, financing, transportation, manufacturing and energy, the 3C3 PRO series is the best choice of UPS.







The following functions of the 3C3 PRO series ensure high quality power for your equipment:

- Advanced DSP digital control technology enabling improved product performance and system reliability.
- N+X parallel redundancy (common batteries are allowed).
- Excellent protection to harsh industrial environment.
- Economic and safe ECO operation model that ensures 98% or higher USP efficiency.
- High-resolution LCD that ensures clear and easy operation.
- Powerful communications interface and remote monitor.
- Plenty of accessories that meet a variety of needs.



1.2 Frequently used symbols

The following symbols may appear in the manual or other occasions. You are suggested to understand the symbols and their meanings.

Symbols and Indications	
Symbol	Description
	Attention
	Dangerous high voltage
	Alternating current(AC)
	Direct current(DC)
	Grounding Protection
	Recycle
	Do not dispose with sundries

Chapter 2 Appearance Description

2.1 Unpacking and Inspection

1. Unpack the package, the unit should contain the following items:
 - 1) 1 UPS
 - 2) Accessories, including User Manual, RoHS Certificate of Compliance and 2 door keys.
2. Check to see if the UPS is damaged during delivery. In case of any damage or any component missing, please do not start the UPS and contact the carrier or dealer forwarder or distributor immediately.

Note: Make sure that there is a sufficient minimum clearance from any obstacle before moving the UPS.

Figure 1: Cut the packing straps and remove the top cover plate.

Figure 2: Unbend the tucks locking all plates together, then remove these plates.

Figure 3: Remove the plastic bag and foam around the unit.

Figure 4: Remove the shipping brackets fixing the UPS to the pallet.

Figure 5: Attach the ramp to the front of the pallet.

Figure 6: Roll the UPS down the ramp and move it to the installation spot.

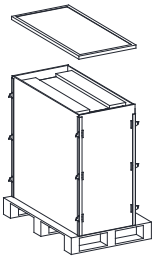

Figure 1

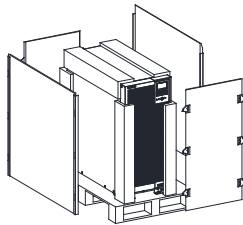

Figure 2

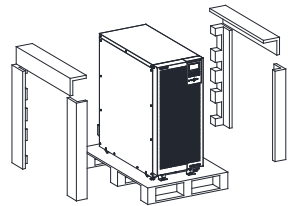

Figure 3

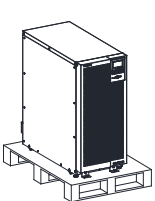

Figure 4

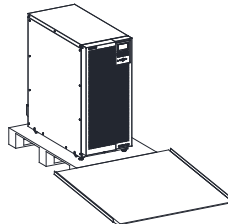
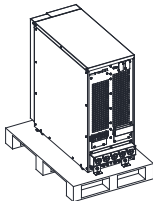

Figure 5

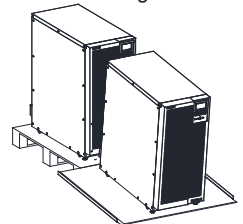
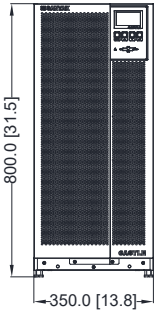

Figure 6

2.2 UPS Cabinet Dimensions

3C3 PRO 20KS/30KS/40KS Cabinet Dimensions



FRONT VIEW

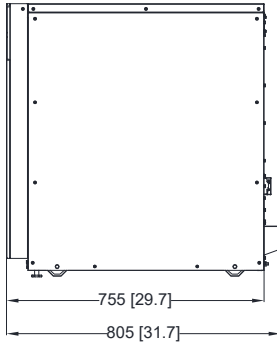

RIGHT VIEW

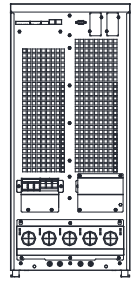

REAR VIEW



TOP VIEW

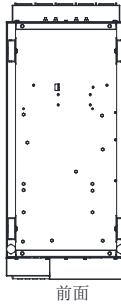

BOTTOM VIEW

3C3 PRO 60KS/80KS Cabinet Dimensions

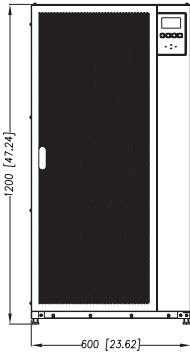

FRONT VIEW

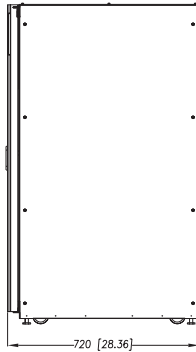

RIGHT VIEW

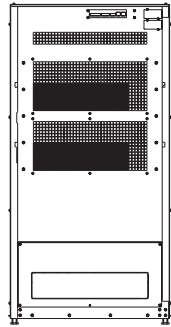

REAR VIEW

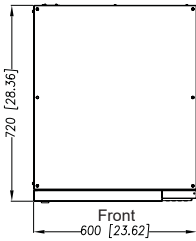

TOP VIEW

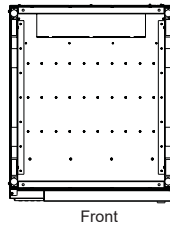

BOTTOM VIEW

3C3 PRO 100KS Cabinet Dimensions

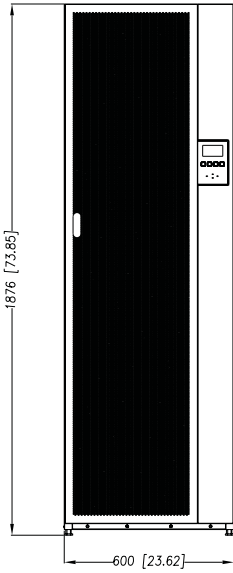

FRONT VIEW

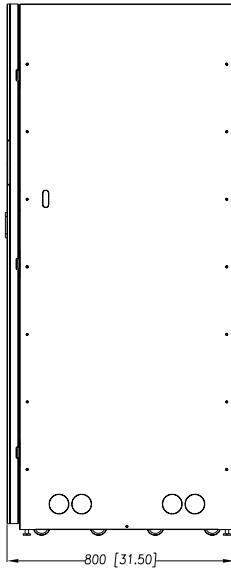

RIGHT VIEW

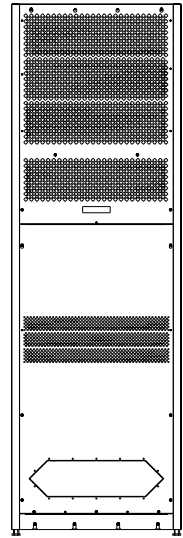

REAR VIEW

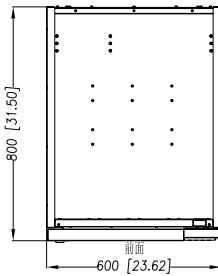

TOP VIEW

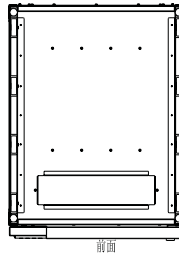

BOTTOM VIEW

3C3 PRO 120KS Cabinet Dimensions

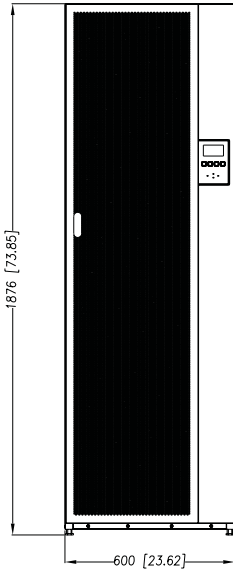

FRONT VIEW

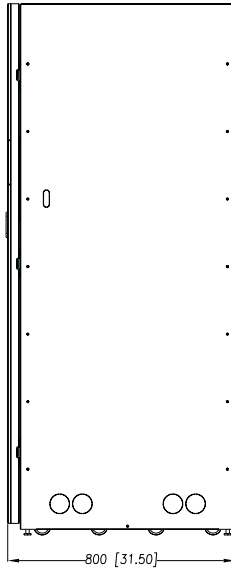

RIGHT VIEW

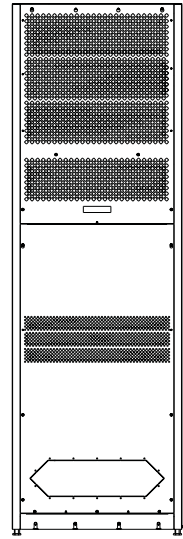

REAR VIEW

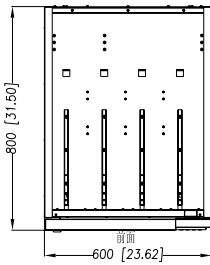

TOP VIEW

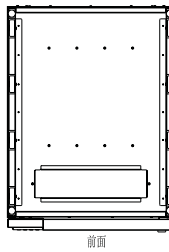

BOTTOM VIEW

3C3 PRO 160KS/200KS Cabinet Dimensions

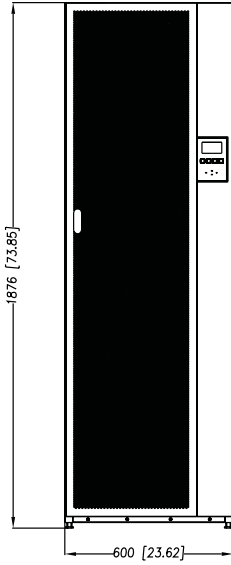

FRONT VIEW

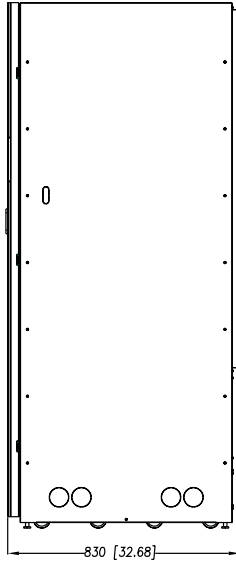

RIGHT VIEW

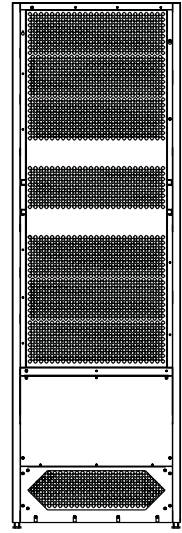

REAR VIEW

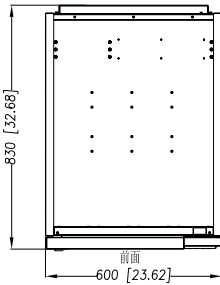

TOP VIEW

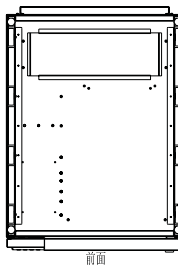

BOTTOM VIEW

Center of Gravity of 3C3 PRO 20KS/30KS/40KS

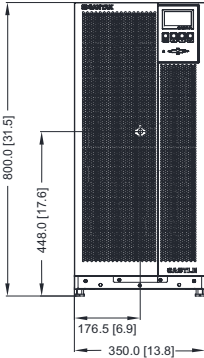

FRONT VIEW

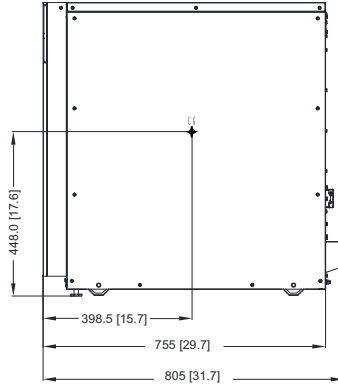

RIGHT VIEW

Center of Gravity of 3C3 PRO 60KS/80KS

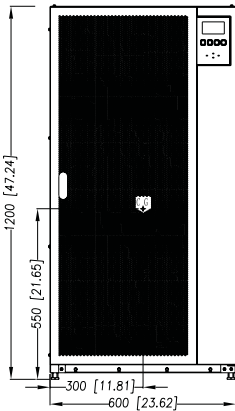

FRONT VIEW

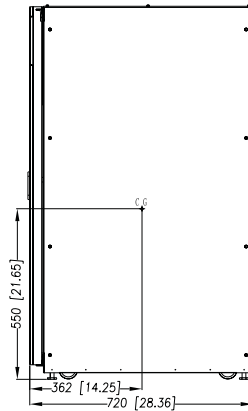

RIGHT VIEW

Center of Gravity of 3C3 PRO 100KS/120KS

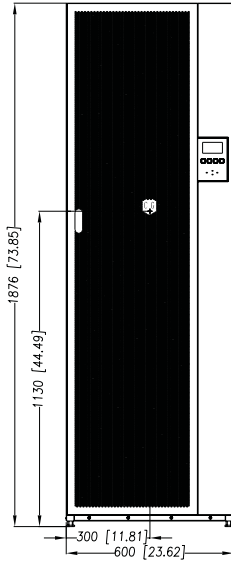

FRONT VIEW

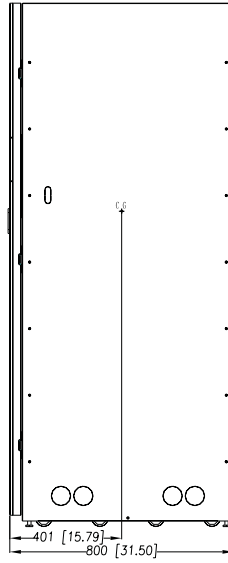

RIGHT VIEW

Center of Gravity of 3C3 PRO 160KS/200KS

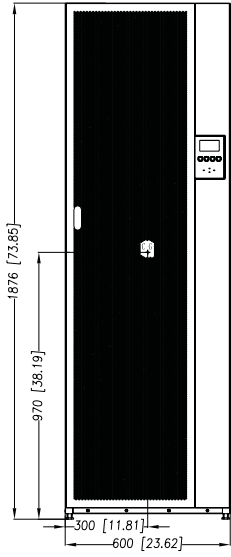

FRONT VIEW

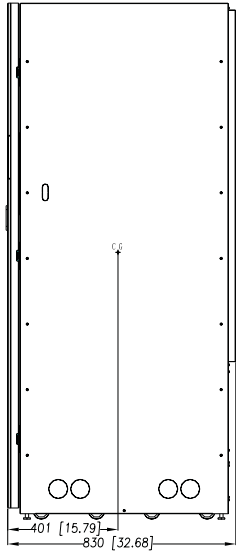

RIGHT VIEW

2.3 LCD Panel Instructions

The LCD panel is a human-machine interface providing information on the operating status of your UPS, including power-on, power-off, status display, fault alarm, and parameter setting. After your UPS is installed, all the operations can be performed with the LCD panel. The LCD panel consists of LED status indicators, a LCD display and navigation pushbuttons. Please refer to the table below for the description of LED status indicators and navigation pushbuttons.

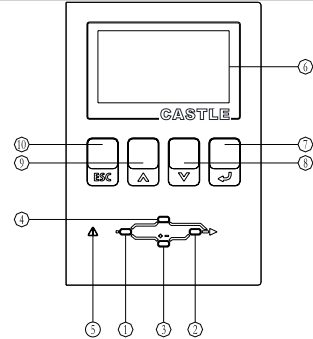

Note: See Appendix II for the description of each LED status indicator.

- LED status indicators: indicating the UPS working mode and status

Identifier	LED Indicator	Color	Status
①	AC	green	UPS is powered directly by AC
②	Inverter	green	UPS is powering through the inverter
③	Battery	yellow	Line input fault, UPS is powering by batteries
④	Bypass	green	UPS is powering the load by AC through bypass
⑤	Fault	red	LED will solid on with continuous warning tone or flash with intermission warning tone in case of UPS abnormal function

- LCD display ⑥: providing detailed information about the UPS
- Navigation pushbuttons: Selecting and opening menu items, accessing information and changing system parameters, etc.

Identifier	Key	Name	Function
⑦	➡	Confirm/ Enter	Select a menu or confirm an operation; confirm the present input password letter and enter the next password letter input process; back to the main menu from the status screen.
⑧	▼	Page Down	Switch to next screen display under the same menu.
⑨	▲	Page UP	Return to last screen display under the same menu.
⑩	Esc	Escape	Return to previous menu or cancel a certain operation; cancel the input password; back to the status screen from the main menu.

Chapter 3 Installation Instructions

3.1 Installation Notice

- 1) The installation of Castle EX series products must be performed in compliance with the electrical code by professional personnel.
- 2) Install the UPS in a clean and stable environment that is free of vibration, dust, high humidity, flammable gas, and flammable liquid or caustic substance.
- 3) To ensure normal UPS performance, ambient temperature should range between 0-40°C. If temperature exceeds 40°C, maximum load should be decreased progressively by 12% of the rated amount along with every increase of temperature by 5°C. The maximum ambient temperature for normal UPS performance should not exceed 50°C.
- 4) It is suggested that battery pack should work within a temperature range from 15°C to 25°C.
- 5) Altitude for normal UPS function should not exceed 1000m. Should UPS be intended for application above 1000m, contact your service representative for important information about high altitude operation.

3.2 Required Clearance for Installation

The UPS cabinet uses forced air cooling to regulate internal component temperature. Air inlets are in the front of the cabinet and outlets are in the back of the cabinet. Allow clearance in front of and in back of the cabinet for proper air circulation.

From Top of Cabinet	≧ 300 mm (12") working space*
From Front of Cabinet	≧ 900 mm (36") working space
From Back of Cabinet	≧ 600 mm (23.6") working space*
From Right Side of Cabinet	≧ 50 mm (2.36") working space*
From Left Side of Cabinet	≧ 50 mm (2.36") working space*

* some components need top access for 60KS/80KS service operation, please reserve at least 600mm space in the top of unit.

* If customer need smaller clearance requirement of rear side(<600mm), should check with service if it is allowed to move away the UPS when do maintenance.

* 20KS/30KS/40KS UPS are maintained from the side, When installation space is referred to Table, please reserve $\geq 800\text{mm}$ cable length so that the UPS could be moved forward for maintenance, otherwise please reserve $\geq 600\text{mm}$ installation space on left and right sides. Other models of UPS maintenance from the front, installation space please refer to Table.

3.3 Terminals

The standard models of 3C3 PRO 20KS/30KS/40KS/60KS/80KS are single feed, 100KS/120KS/160KS/200KS UPS are dual feed. The UPS can be converted from single feed to dual feed or from dual feed to single feed. All operations should only be carried out by trained service personnel authorized by Santak.

3C3 PRO 20KS/30KS wiring connection:

1. Terminals:

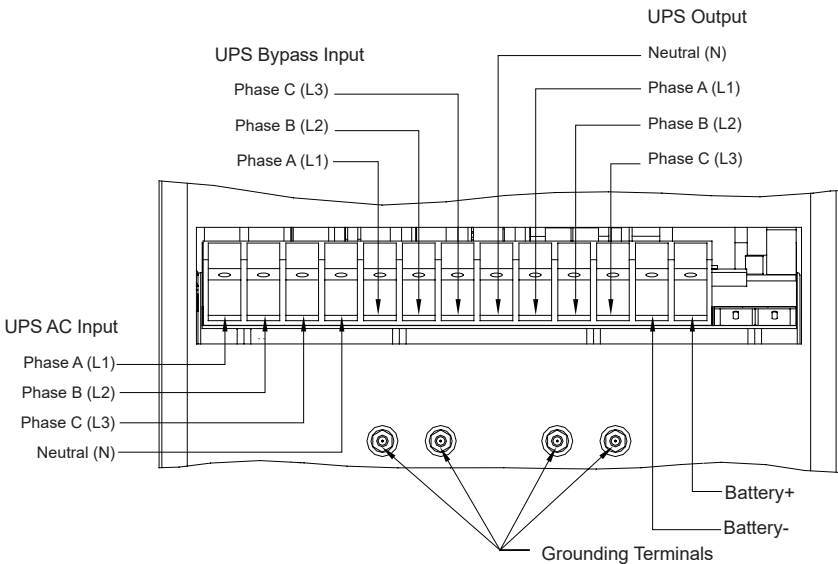

3C3 PRO 40KS wiring connection::

1. Terminals:

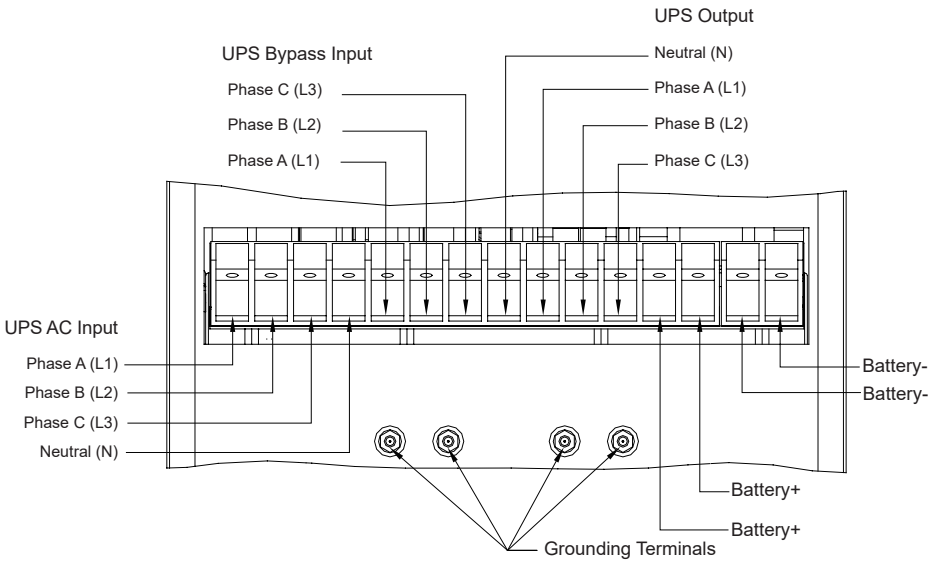

3C3 PRO 60KS/80KS wiring connection:

2. Terminals:

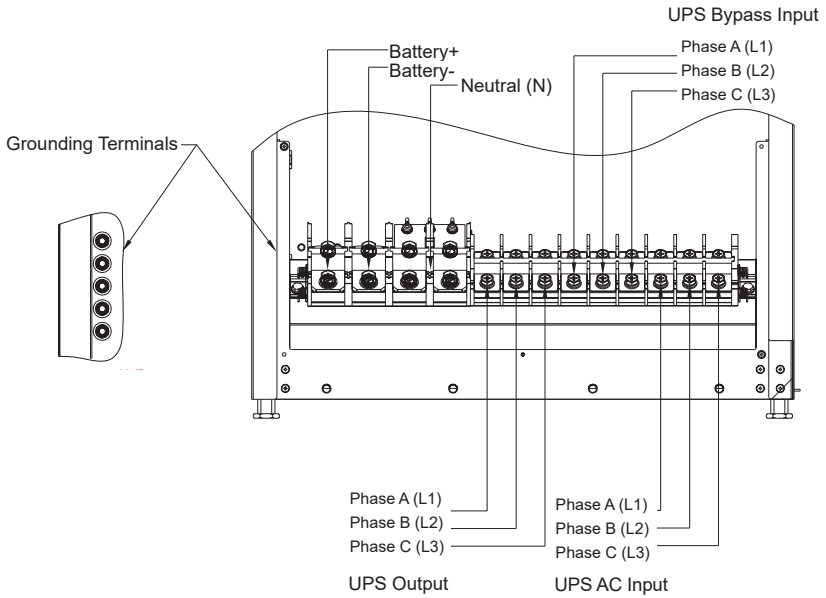

3C3 PRO 100KS/120KS wiring connection:

3. Terminals:

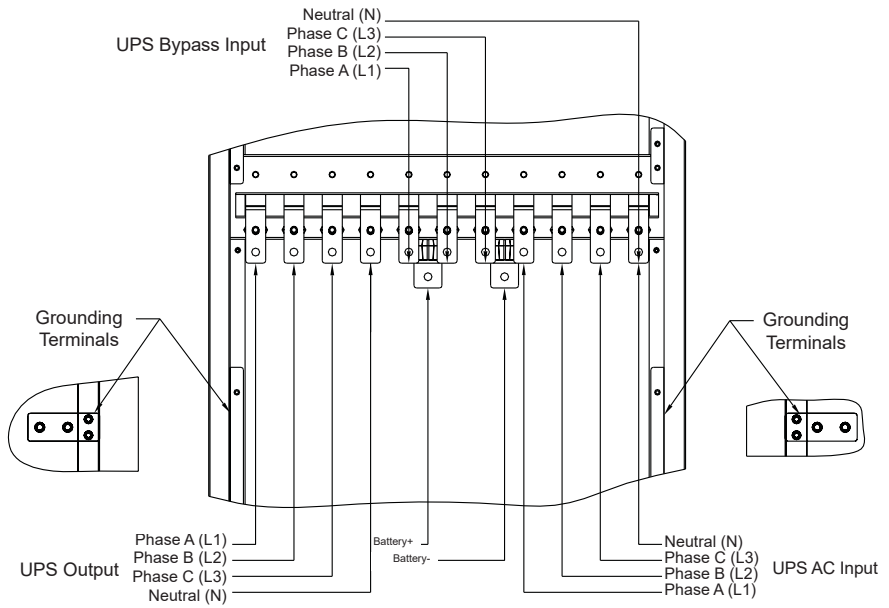

3C3 PRO 160KS/200KS wiring connection:

4. Terminals:

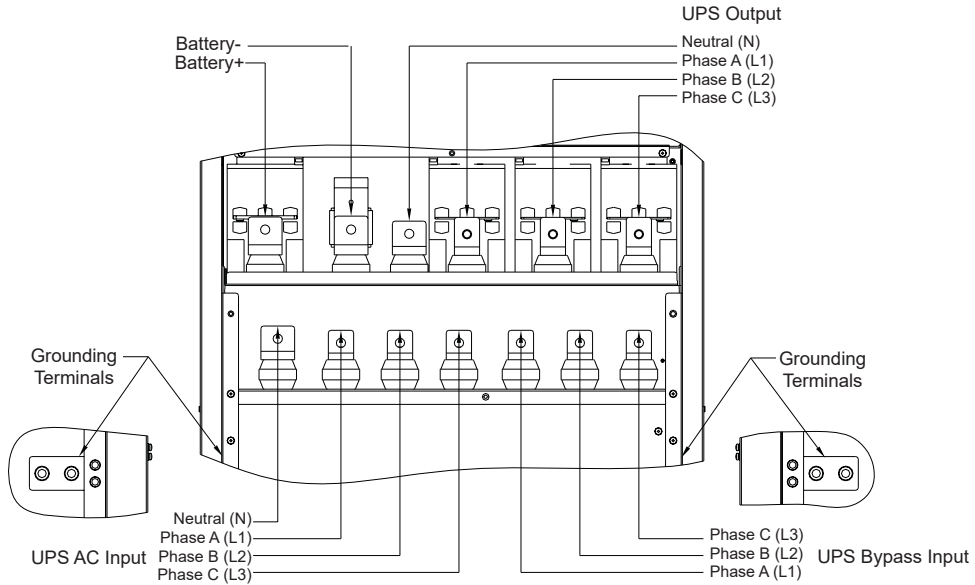

Notes:

1. Please make sure that the input power is three-phase with 4 wires, and the input voltage is within the allowable voltage range(refer to Appendix 1).
2. Make sure the input power phase sequence is close-wise and battery polarities are correctly connected.

3.4 Wiring requirements and protective devices for 3C3 PRO series

External batteries of 3C3 PRO series UPS should be groups of battery packs with the same capacity, 20-80kVA, 28-36 block, default 32 block, the battery voltage should be within 336V-432V; 100-200kVA, 36-40 block, default 40 block, the battery voltage should be within 432V-480V. The number and total capacity of the battery packs are at your option. The battery packs must be equipped with a DC switch and DC fuse, and overload and line voltage should also be taken into consideration for wire diameter selection. Please refer to the table below for details:

Rated Capacity	Cross-sections refer to the IEC 62040-1	Unit					
		kVA kW	20 18	30 27	40 36	60 54	80 72
Input /Output Voltage		Volts	400/400	400/400	400/400	400/400	400/400
AC Input Full Load Current (three-phase, one neutral wire, one ground wire)		Amps	31	46	61	92	122
Wire Size (A/B/C/N wire size)	min	mm ²	6×1	6×1	16×1	16×1	25×1
	max	mm ²	10×1	25×1	25×1	50×1	70×1
Bypass Input Full Load Current (three-phase, one neutral wire, one ground wire)		Amps	29	43	58	87	116
Wire Size (A/B/C/N wire size)	min	mm ²	6×1	6×1	16×1	16×1	25×1
	max	mm ²	10×1	25×1	25×1	50×1	70×1
DC Input Current (32 block of batteries) (one positive wire, one negative wire)		Total Amps	46	69	92	151	202
Power Wiring Size (positive and negative)	min	mm ²	6×1	10×1	16×1	35×1	50×1
	max	mm ²	25×1	35×1	50×1	50×2	70×2
AC Output Current (three-phase, one neutral wire, one ground wire)		Amps	29	43	58	87	116
Input Wiring Size (A/B/C/N wire size)	min	mm ²	6×1	6×1	16×1	16×1	25×1
	max	mm ²	10×1	25×1	25×1	50×1	70×1
Grounding			1.0 times				
neutral wire (N wire)			1.7 times				

Rated Capacity	Cross-sections refer to the IEC 62040-1	Unit				
		kVA kW	100 90	120 108	160 144	200 180
Input /Output Voltage		Volts	400/400	400/400	400/400	400/400
AC Input Full Load Current (three-phase, one neutral wire, one ground wire)		Amps	154	187	248	309
Wire Size (A/B/C/N wire size)	min	mm ²	35×1	50×1	70×1	95×1
	max	mm ²	95×1	120×1	150×1	240×1
Bypass Input Full Load Current (three-phase, one neutral wire, one ground wire)		Amps	144	173	231	298
Wire Size (A/B/C/N wire size)	min	mm ²	35×1	50×1	70×1	95×1
	max	mm ²	95×1	120×1	150×1	240×1
DC Input Current (32 block of batteries) (one positive wire, one negative wire)		Total Amps	206	247	330	412
Power Wiring Size (positive and negative)	min	mm ²	50×1	70×1	185×1	300×1
	max	mm ²	120×1	150×1	400×2	400×2
AC Output Current (three-phase, one neutral wire, one ground wire)		Amps	144	173	231	289
Input Wiring Size (A/B/C/N wire size)	min	mm ²	35×1	50×1	70×1	95×1
	max	mm ²	95×1	120×1	150×1	240×1
Grounding			1.0 times			
neutral wire (N wire)			1.7 times			

NOTE:

1. Before connecting to the UPS, a proper three pole over-current circuit breaker should be installed in the power distribution system, with Phase A, Phase B, Phase C disconnected , and Neutral switch is optional.
2. For single-phase current exceeding 100A, the air circuit breakers used must feature an arc-quenching mechanism. It is suggested that the clients be equipped with a UL-listed D-curve air circuit breakers.
3. Positive/negative battery wire diameter refers to the diameter of the wires

used to connect the UPS and the battery cabinet; the positive wire is red and negative wire black.

- The positive and negative battery wires, which must be of the same length and should not be longer than 40m.

3C3 PRO 20KS\30KS\40KS UPS External Power Source Terminals

Terminals Function	Terminals	Function	Bus landing	Tightening Torque Nm (lb in)	Screw Size and Type
AC Mains Input to UPS Rectifier	L1	Phase A	M6 bolt mounting	5 (44)	28.26 mm ² (M6).
	L2	Phase B	M6 bolt mounting	5 (44)	28.26 mm ² (M6)
	L3	Phase C	M6 bolt mounting	5 (44)	28.26 mm ² (M6)
	N	Neutral	M6 bolt mounting	5 (44)	28.26 mm ² (M6)
AC Mains Input to Bypass	L1	Phase A	M6 bolt mounting	5 (44)	28.26 mm ² (M6)
	L2	Phase B	M6 bolt mounting	5 (44)	28.26 mm ² (M6)
	L3	Phase C	M6 bolt mounting	5 (44)	28.26 mm ² (M6)
	N	Neutral	M6 bolt mounting	5 (44)	28.26 mm ² (M6)
UPS Output to Loads	L1	Phase A	M6 bolt mounting	5 (44)	28.26 mm ² (M6)
	L2	Phase B	M6 bolt mounting	5 (44)	28.26 mm ² (M6)
	L3	Phase C	M6 bolt mounting	5 (44)	28.26 mm ² (M6)
	N	Neutral	M6 bolt mounting	5 (44)	28.26 mm ² (M6)
DC Input	+	Battery (+)	M6 bolt mounting	5 (44)	28.26 mm ² (M6)
	-	Battery (-)	M6 bolt mounting	5 (44)	28.26 mm ² (M6)
Grounding	Ground		M6 bolt mounting	5 (44)	28.26 mm ² (M6)

3C3 PRO 60KS\80KS UPS External Power Source Terminals

Terminals Function	Terminals	Function	Bus landing	Tightening Torque Nm (lb in)	Screw Size and Type
AC Mains Input to UPS Rectifier	L1	Phase A	M8 bolt mounting	15 (133)	50.24 mm ² (M8)
	L2	Phase B	M8 bolt mounting	15 (133)	50.24 mm ² (M8)
	L3	Phase C	M8 bolt mounting	15 (133)	50.24 mm ² (M8)
	N	Neutral	M10 bolt mounting	24 (213)	78.5 mm ² (M8)
AC Mains Input to Bypass	L1	Phase A	M8 bolt mounting	15 (133)	50.24 mm ² (M8)
	L2	Phase B	M8 bolt mounting	15 (133)	50.24 mm ² (M8)
	L3	Phase C	M8 bolt mounting	15 (133)	50.24 mm ² (M8)
	N	Neutral	M10 bolt mounting	24 (213)	78.5 mm ² (M8)
UPS Output to Loads	L1	Phase A	M8 bolt mounting	15 (133)	50.24 mm ² (M8)
	L2	Phase B	M8 bolt mounting	15 (133)	50.24 mm ² (M8)
	L3	Phase C	M8 bolt mounting	15 (133)	50.24 mm ² (M8)
	N	Neutral	M10 bolt mounting	24 (213)	78.5 mm ² (M8)
DC Input	+	Battery (+)	M10 bolt mounting	24 (213)	78.5 mm ² (M8)
	-	Battery (-)	M10 bolt mounting	24 (213)	78.5 mm ² (M8)
Grounding		Ground	M8 bolt mounting	15 (133)	50.24 mm ² (M8)

3C3 PRO 160KS\200KS UPS External Power Source Terminals

Terminals Function	Terminals	Function	Bus landing	Tightening Torque Nm (lb in)	Screw Size and Type
AC Mains Input to UPS Rectifier	L1	Phase A	M10 bolt mounting	24 (212)	78.540 mm ² (M10)
	L2	Phase B	M10 bolt mounting	24 (212)	78.540 mm ² (M10)
	L3	Phase C	M10 bolt mounting	24 (212)	78.540 mm ² (M10)
	N	Neutral	M10 bolt mounting	24 (212)	78.540 mm ² (M10)
AC Mains Input to Bypass	L1	Phase A	M10 bolt mounting	24 (212)	78.540 mm ² (M10)
	L2	Phase B	M10 bolt mounting	24 (212)	78.540 mm ² (M10)
	L3	Phase C	M10 bolt mounting	24 (212)	78.540 mm ² (M10)
	N	Neutral	M10 bolt mounting	24 (212)	78.540 mm ² (M10)
UPS Output to Loads	L1	Phase A	M10 bolt mounting	24 (212)	78.540 mm ² (M10)
	L2	Phase B	M10 bolt mounting	24 (212)	78.540 mm ² (M10)
	L3	Phase C	M10 bolt mounting	24 (212)	78.540 mm ² (M10)
	N	Neutral	M10 bolt mounting	24 (212)	78.540 mm ² (M10)
DC Input	+	Battery (+)	M10 bolt mounting	24 (212)	78.540 mm ² (M10)
	-	Battery (-)	M10 bolt mounting	24 (212)	78.540 mm ² (M10)
Grounding		Ground	M10 bolt mounting	24 (212)	78.540 mm ² (M10)

Recommended Input Circuit Breaker and Output Circuit Breaker Ratings

UPS Models	Circuit Breaker Rating	
	Load	400Vac
3C3 PRO-20	80% -rated	38A
	100% -rated	31A
3C3 PRO-30	80% -rated	57A
	100% -rated	46A
3C3 PRO-40	80% -rated	77A
	100% -rated	61A
3C3 PRO-60	80% -rated	115A
	100% -rated	92A
3C3 PRO-80	80% -rated	153A
	100% -rated	123A
3C3 PRO-100	80% -rated	192A
	100% -rated	154A
3C3 PRO-120	80% -rated	234A
	100% -rated	187A
3C3 PRO-160	80% -rated	310A
	100% -rated	248A
3C3 PRO-200	80% -rated	386A
	100% -rated	309A

Recommended Bypass Circuit Breaker and Bypass Fuse Ratings

UPS 型号	Circuit Breaker		Fuse Parameters	
	Rated Voltage/min 400Vac		Rated Voltage/min 400Vac	
	Rated Current	Tripp characteristic	Current/Min	I ² T/Max
3C3 PRO-20	40A	C or D	40A	10200A ² Sec
3C3 PRO-30	63A	C or D	63A	10200A ² Sec
3C3 PRO-40	80A	C or D	80A	20400A ² Sec
3C3 PRO-60	125A	C or D	125A	72500A ² Sec
3C3 PRO-80	160A	C or D	160A	72500A ² Sec
3C3 PRO-100	200A	C or D	200A	202500A ² Sec
3C3 PRO-120	250A	C or D	250A	202500A ² Sec
3C3 PRO-160	300A	C or D	300A	225000A ² Sec
3C3 PRO-200	400A	C or D	400A	225000A ² Sec

Recommended DC Circuit Breaker Ratings

UPS Model	Rated Voltage	500Vdc	600Vdc
	Load	Current (32 block)	Current (40 block)
3C3 PRO-20	80% -rated	63A	NA
	100% -rated	50A	NA
3C3 PRO-30	80% -rated	95A	NA
	100% -rated	76A	NA
3C3 PRO-40	80% -rated	126A	NA
	100% -rated	101A	NA
3C3 PRO-60	80% -rated	189A	NA
	100% -rated	151A	NA
3C3 PRO-80	80% -rated	252A	NA
	100% -rated	202A	NA
3C3 PRO-100	80% -rated	NA	257A
	100% -rated	NA	206A
3C3 PRO-120	80% -rated	NA	309A
	100% -rated	NA	247A
3C3 PRO-160	80% -rated	NA	412A
	100% -rated	NA	330A
3C3 PRO-200	80% -rated	NA	515A
	100% -rated	NA	412A

3.5 Parallel Installation

The 3C3 PRO Series support parallel installation. The parallel connection wires (optional) can be used to connect 2 to 4 UPS units in parallel to achieve power redundancy (N+X). The minimum clearance between two UPS units is 10cm. The input wiring requirements for paralleled UPS units are the same with those for single unit. The input/output of paralleled UPS units should all be connected to the same input/output patch board, from which wires are distributed for load as illustrated in the following figure:

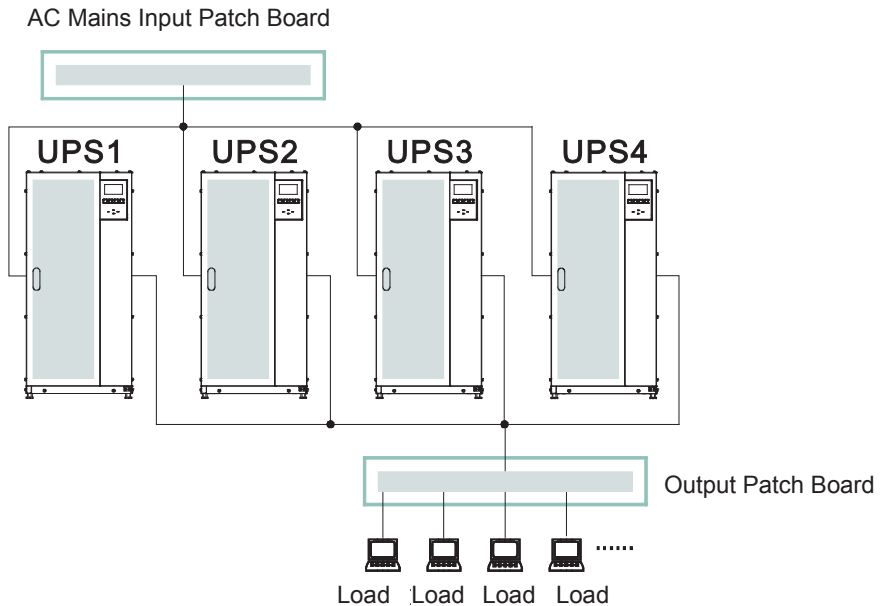

NOTE:

1. Paralleled UPS units can share the battery packs for 20-80kVA; The batteries of each battery pack should be batteries of the same type and from the same batch produced by the same manufacturer;
2. Requirements for output wire length:
 - ① When the wires connecting the input (output) terminals of paralleled UPS units with the input (output) patch board are shorter than 20m, the difference in wire length should be smaller than 20% of the length
 - ② When the wires connecting the input (output) terminals of paralleled UPS units to the input (output) patch board are longer than 20m, the difference should be smaller than 10%.

Parallel machine wire connection drawing:

3C3 PRO 20KS/30KS/40KS UPS

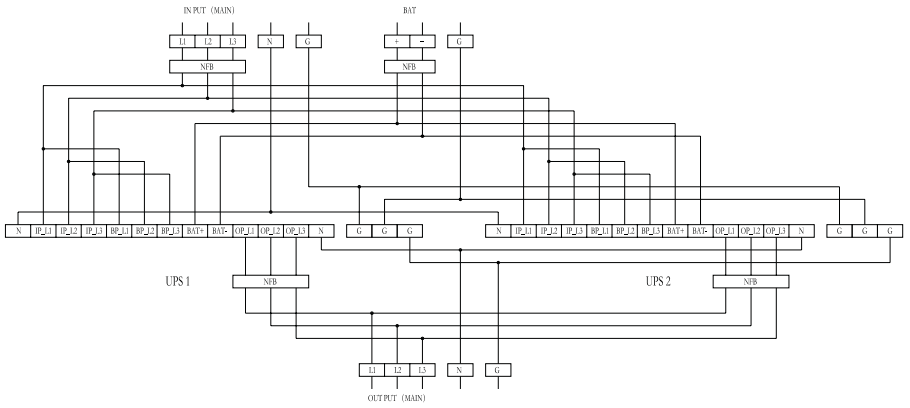

3C3 PRO 60KS/80KS UPS

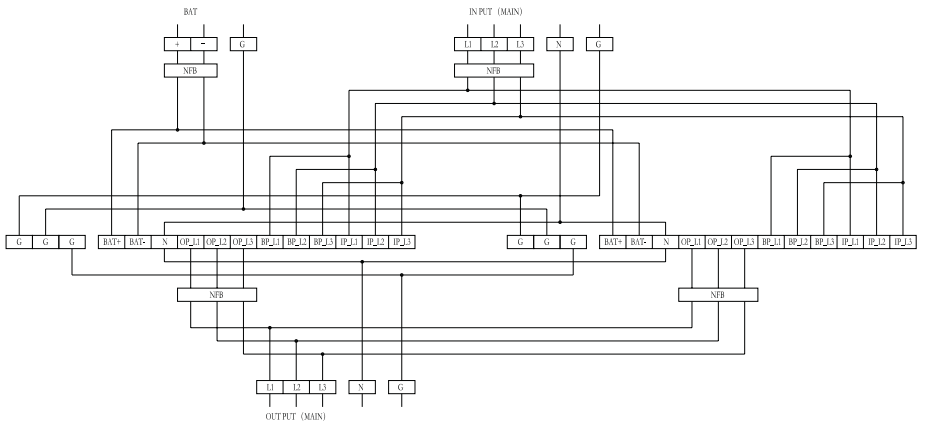

3C3 PRO 100KS/120KS UPS

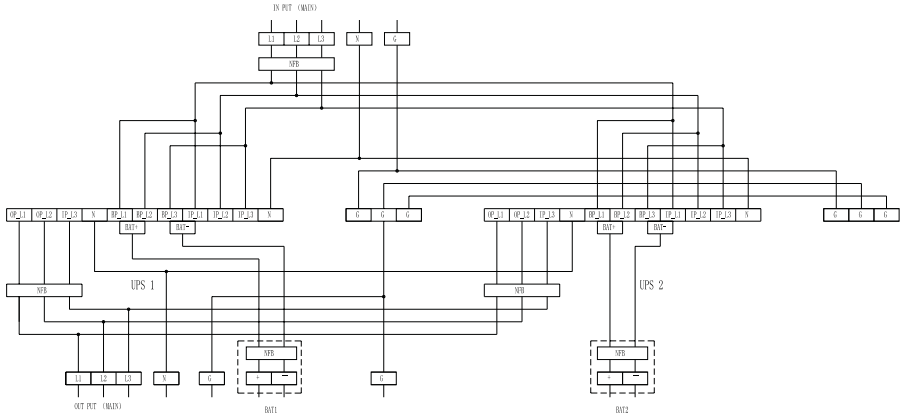

3C3 PRO 160KS/200KS UPS

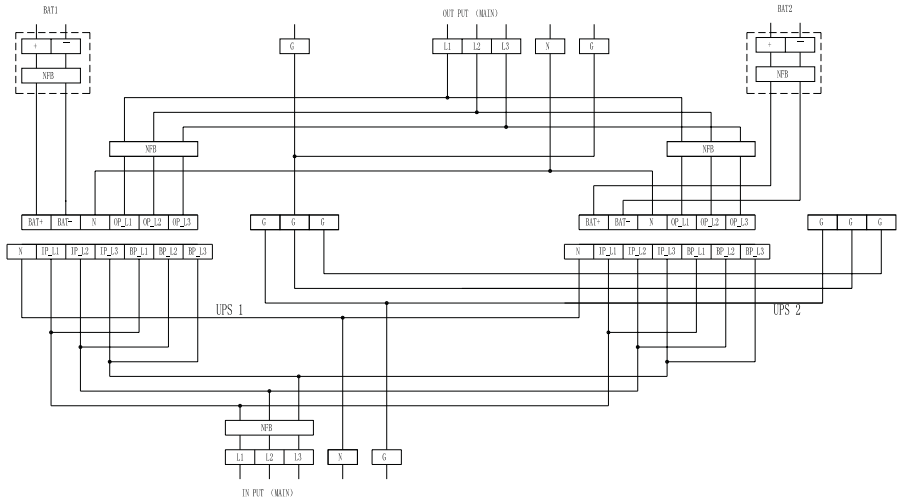

3.6 Steps of connecting battery cabinets to UPS

A proper over-current circuit breaker should be installed between the battery cabinet and the UPS. To choose the right circuit breakers, please refer to the tables in the above section.

Make sure that the input and output terminals is non-electrified and the external battery sockets are power off.

1. Switch off the battery breaker of battery cabinet.
2. Remove the cover on the terminals bay and connect the "+" and "-" wires from the UPS terminals to "+" and "-" wires of the battery box; make sure the battery polarities are correct.

Use multi-meter (DC Voltage) to measure the voltage of positive and negative batteries as well as positive and negative polarity, make sure the positive and negative connectivity is correct then put the cover back on the terminals bay.

NOTE: To prevent electric shock, the installation and replacement of battery must be performed by professional personnel and after the UPS is shut down.

Chapter 4 Operation

4.1 Operations of Single UPS

1. Make sure Phase A, B and C are in correct phase sequence, and then supply power to the UPS.
2. Turn on the battery (make sure that the battery "+" and "-" terminals are correctly connected to the UPS terminals).
3. Turn on the "Input Switch" on the UPS (the AC Input Switch), and the UPS will start to check its functionality with the cooling fan operating. You will access the main menu in about 4 seconds. Then please operate according to the following screen display.

NOTE: The data shown in the following pictures on the operations of 3C3 PRO 80KS are for reference only.

1) Turn on the "Input Switch", and the UPS will start to check its functionality, The main menu will be displayed after 15 seconds of inactivity.

2) Get to the main menu.

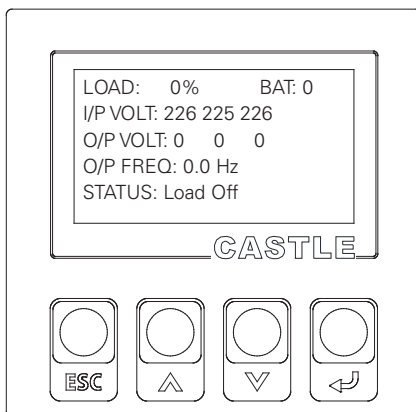
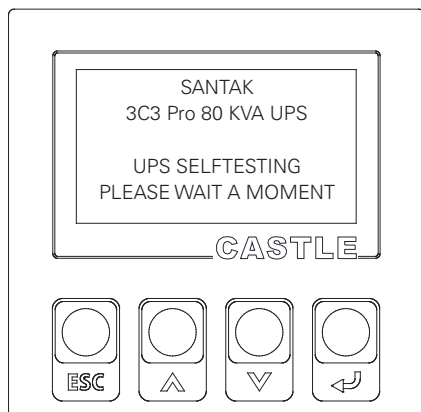

3) Press the ▼ button for the following information.

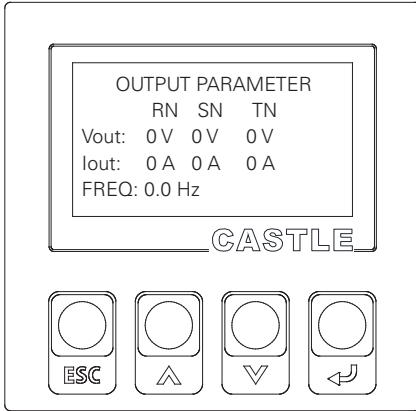

4) Press the ▼ button for the following information.

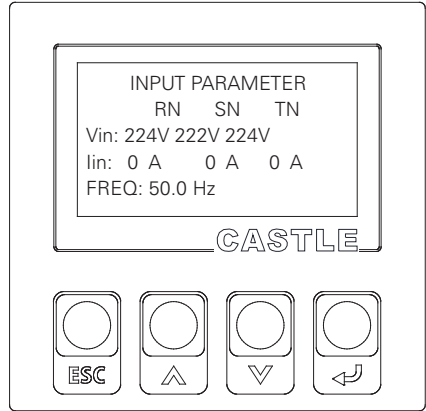

5) Press the ▼ button for the following information.

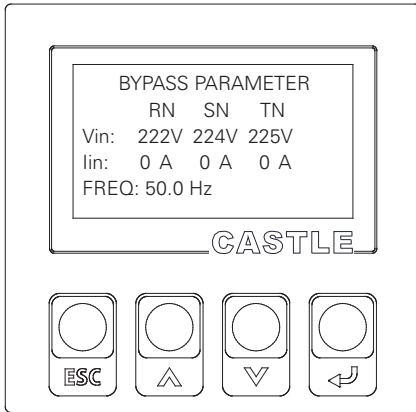

6) Press the ▼ button for the following information.

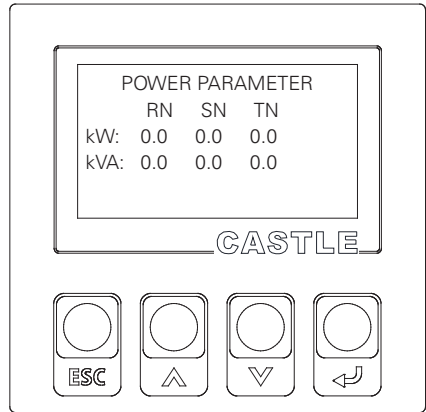

7) Press the ▼ button for the following information.

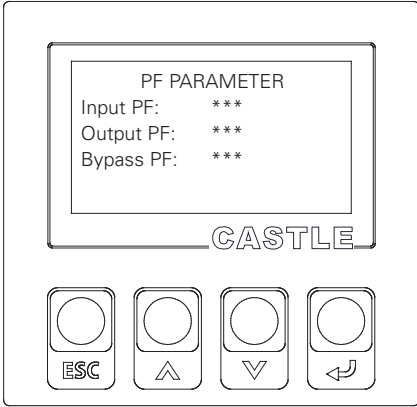

8) Press the ▼ button for the following information.

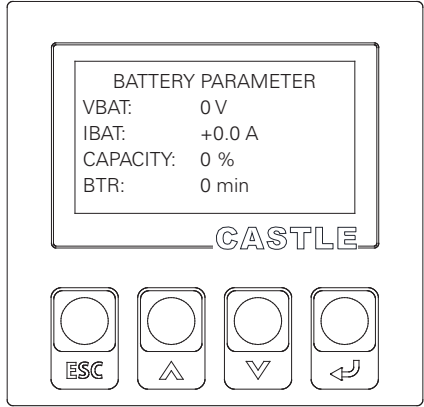

9) Press the ▼ button for the following information.

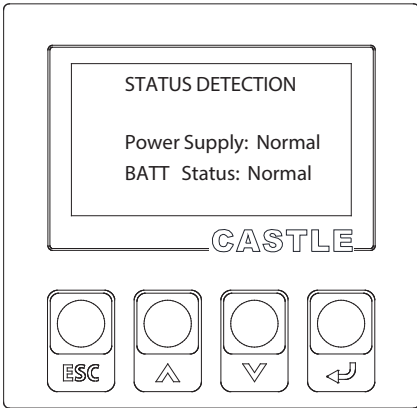

10) Press the ▼ button for the following information.

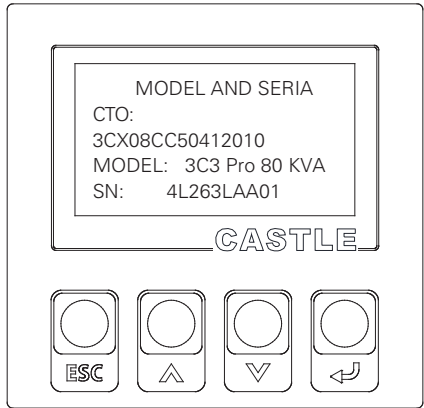

11) Press the ▼ button for the following information.

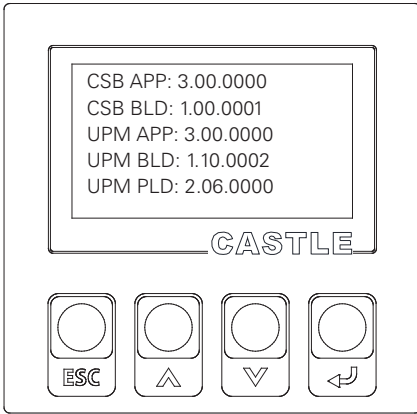

12) Press the ▼ button for the following information.

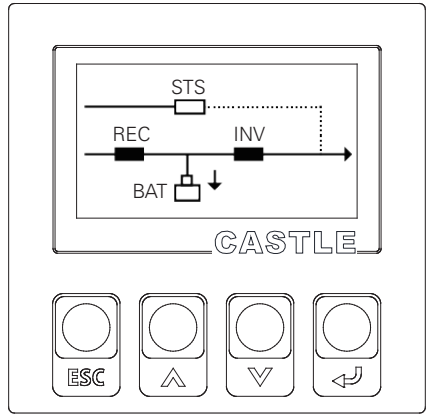

4. Start-up and shut-down operations

1) Access the control interface.

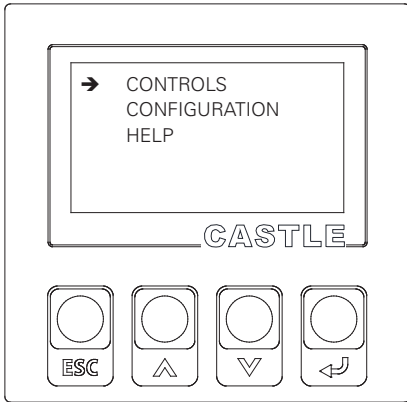

2) Press the ENTER button.

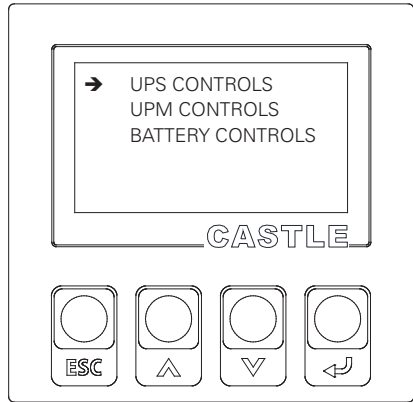

3) Select "Start-up".

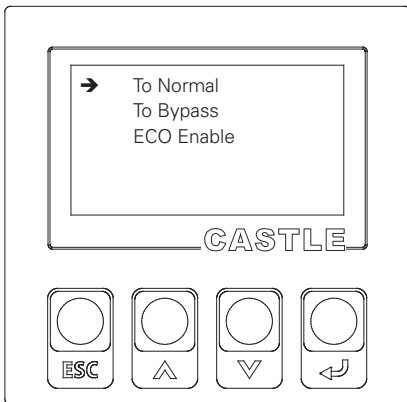

4) Enter the password to access the home page.

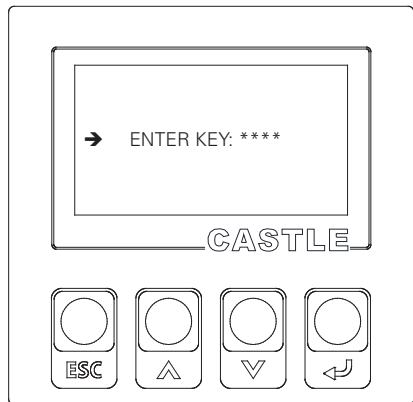

5) Select "Shut-down".

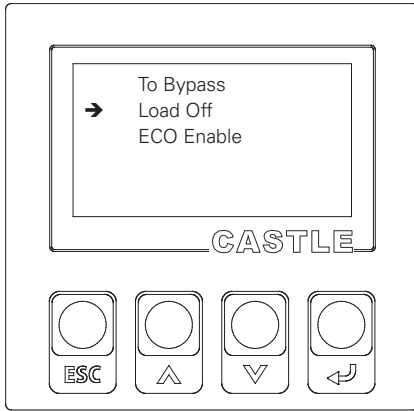

6) Confirm that you want to shut down the UPS.

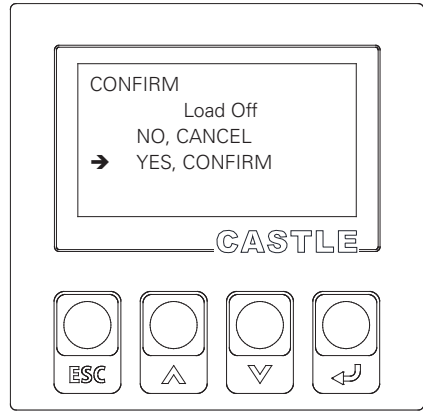

The 3C3 PRO series can start and operate with battery in the absence of AC mains supply, with a panel display similar to that in the case of AC supply. You can just follow the instructions displayed on the panel to start or shut down the UPS with battery:

- Make sure that the battery "+" and "-" terminals and the N wire are correctly connected to the UPS.
- Turn on the battery.
- Press the ENTER button.
- The LCD will undergo a self-test. Please manually start the UPS within 40s after the LCD self-test is completed.

NOTE: The power supply to the UPS will be automatically cut off if there is no operation within 40s after the LCD self-test is completed!

5. Enter the start-up password to access the Settings page to configure the following settings:

1) Press the ▼ button and select "Settings".

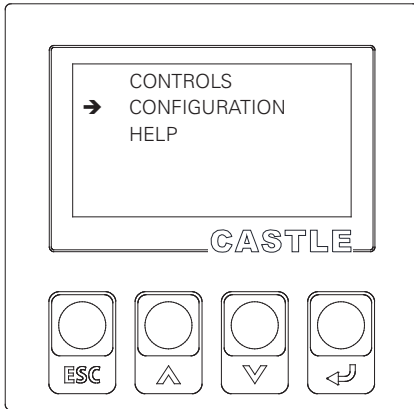

2) User/Service password setting page
Access the User Setting page; Enter the service password To access the Service Personnel setting page .

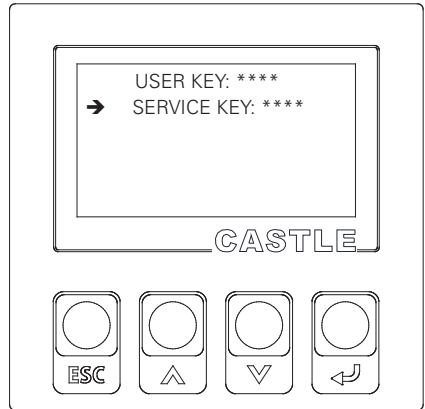

3) User Setting page.

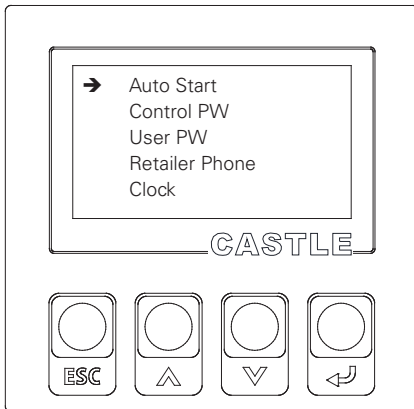

4) Retailer Telephone Number setting page.

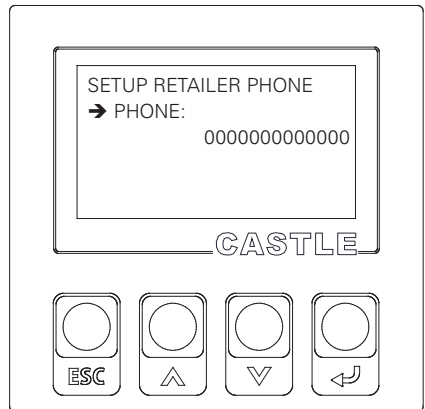

6. Inquiry

1) You can access the Inquiry page by entering the start-up password.

2) Inquiry page.

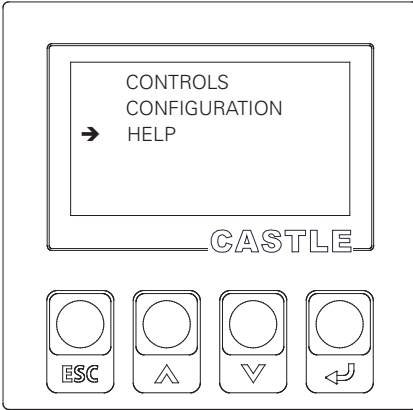

3) Hot-line and dealer Telephone

Number inquiry page (for China market only).

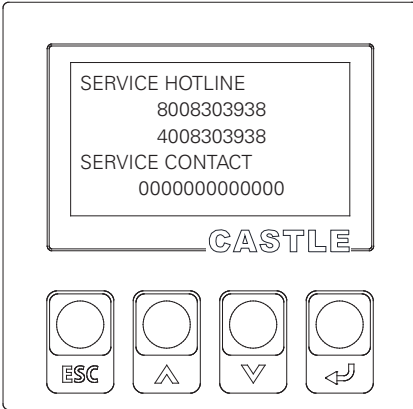

4.2 Operations of UPS in Parallel Connection

1) Enter the user password or service password.

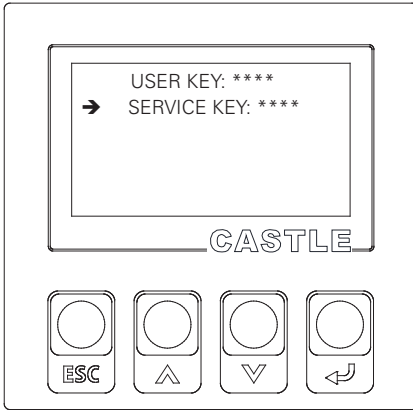

2) Access the UPS Parallel Connection Setting page.

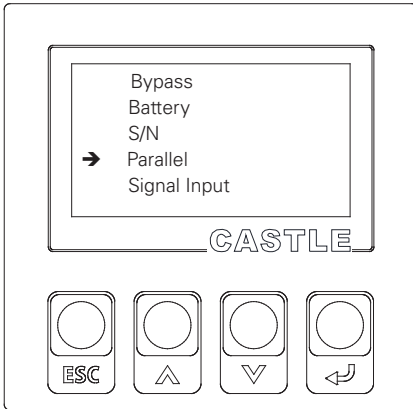

3) UPS Parallel Connection Parameter Setting page.

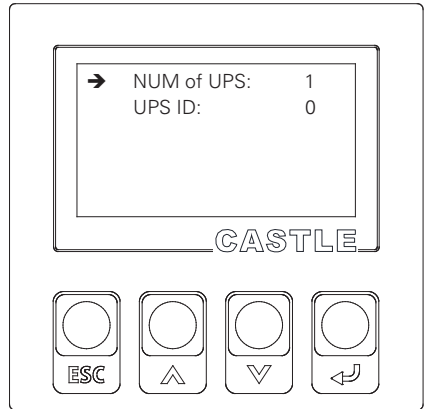

Chapter 5 Communications Interface

The 3C3 PRO series provide Expansion Slot, Parallel (RJ45) and REPO as well as special communication tools used by SANTAK service engineer or technical personnel authorized by SANTAK.

3C3 PRO 20KS/30KS/40KS

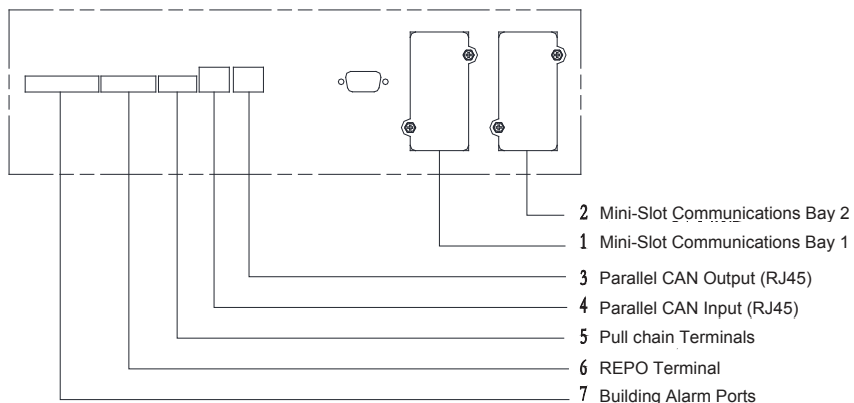

3C3 PRO 60KS/80KS

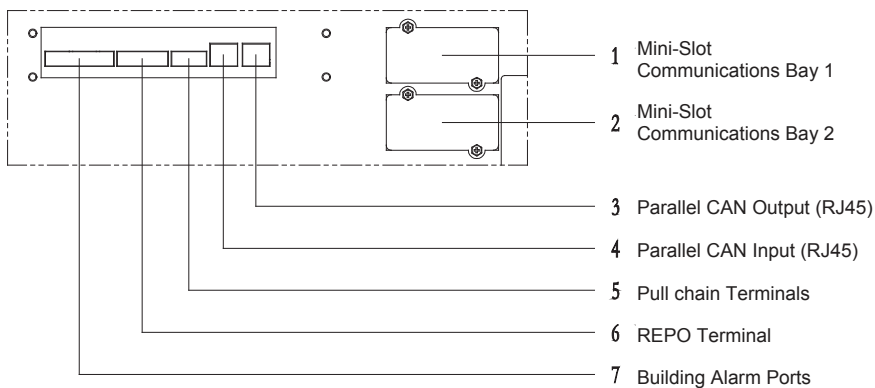

3C3 PRO 100KS/120KS

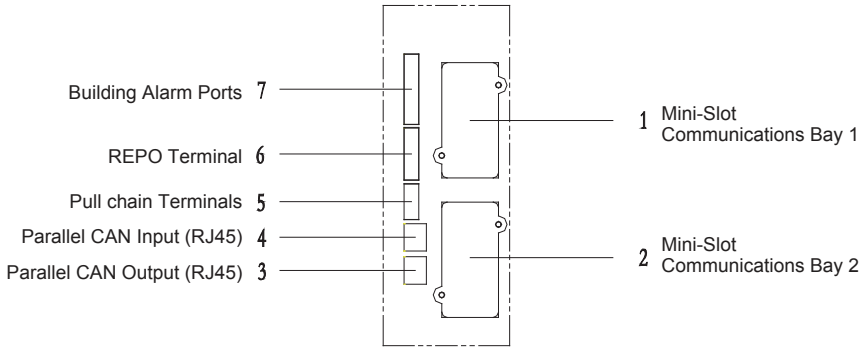

3C3 PRO 160KS/200KS

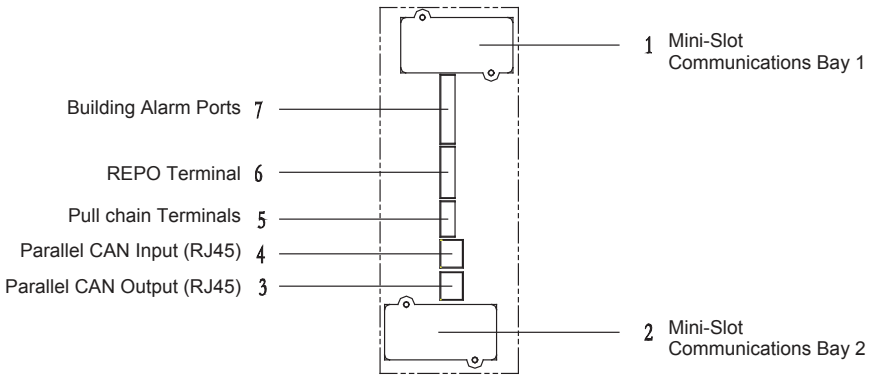

- 1 (2) Expansion slots: Slots exclusively available on the 20KS-200KS models and only accessible by users with special requirements. Standard users have no access to the slots.
- 3. Parallel Connection Terminals (RJ45) Parallel CAN Output used for communications between paralleled UPS units. Up to four 20KS-200KS models can be connected in parallel.
- 4. Parallel Connection Terminals (RJ45) Parallel CAN Input.
- 5. Pull chain Terminals: Check to make sure the UPS system is shut down, and connect the UPS intended for parallel connection according to the parallel connection diagram.
- 6. The REPO is used for emergency shutdown, which enables users to cut

off the UPS output in case of an emergency.

- 7. Building Alarm Ports This standard feature enables you to connect UPS ports to your building alarms, such as " On generator" . Please use twisted-pair wires to connect the alarms and the corresponding UPS ports. You can choose which building alarm you want to connect to a certain UPS port through LCD.

If you have any questions on the use of the above communications terminals, please call SANTAK's local distributors or email to santak_int@eaton.com.

Pull Chain Terminals:

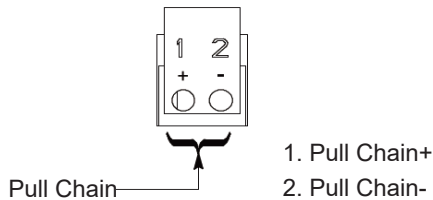

REPO external wiring:

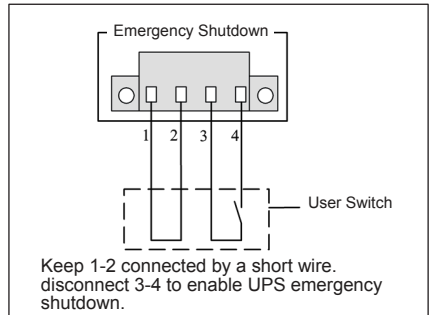
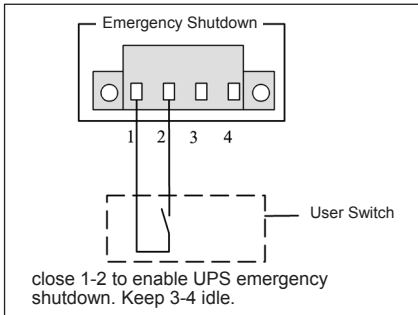

Pullchain external wiring:

NOTE:

- Parallel system combined input and output cable length should be in accordance with the following rule. It should be designed to ensure that wiring impedance from point of supply to UPS input and from UPS output to load connection for each UPS module in a multi-module system is equal, or within a tolerance of approximately $\pm 10\%$. This is to ensure approximately equal current sharing when in static bypass mode and restrain input/output high frequency loop current of parallel system. Suggest that parallel system combined input and output cable length no less than 10m, 5m for input and 5m for output.

Total length of 1A=2A=3A=4A

1B=2B=3B=4B

1C=2C=3C=4C

- If installing only two UPS modules (redundant), this requirement is no longer required as each UPS is capable of supporting the full bypass requirement. However, this would preclude future expansion.
- Ensure that each UPS static bypass is fed from a single common source, as is an external bypass switch if installed. If each UPS is fed with a separate rectifier source, please consult Santak for advice on compatibility.

UPS paralleling wiring diagram – without parallel tie cabinet

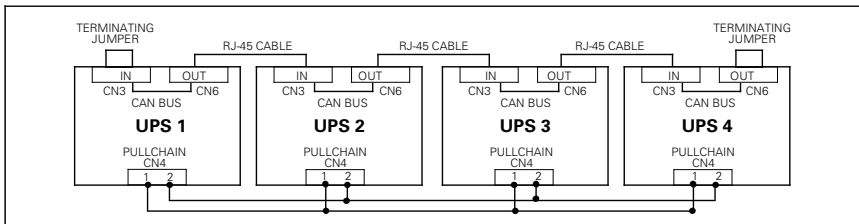

UPS paralleling wiring diagram – with parallel tie cabinet

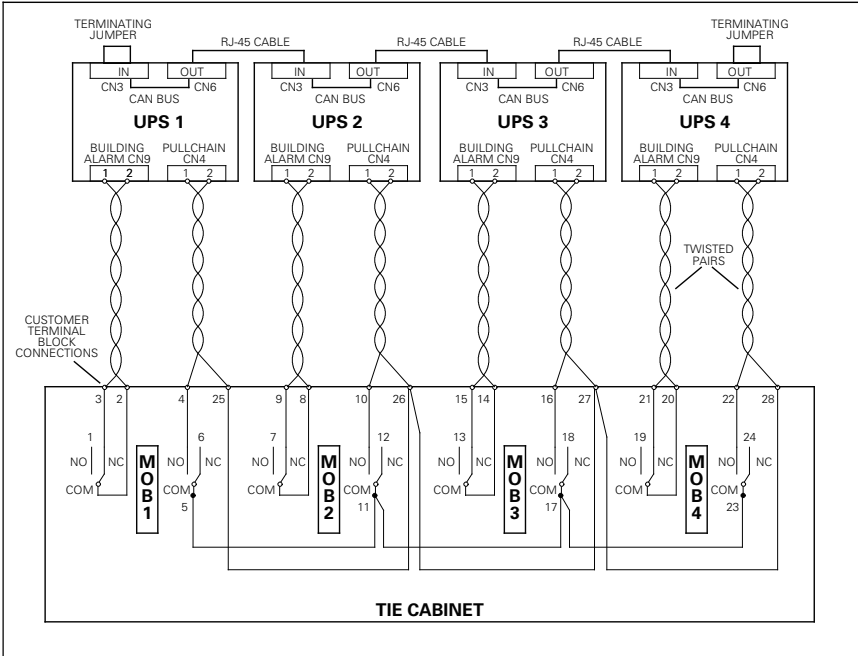

Chapter 6 Optional Accessories

6.1 Dustproof Filter

Dustproof filter is an standard accessory specially designed for the 3C3 PRO series to provide further protection for the front side of the UPS in environments where there is heavy dust (dust diameter no less than 1.0mm, especially metallic and metalloid dust). It is easy to install, replace and clean.

3C3 PRO 20-40KS Dustproof Filter

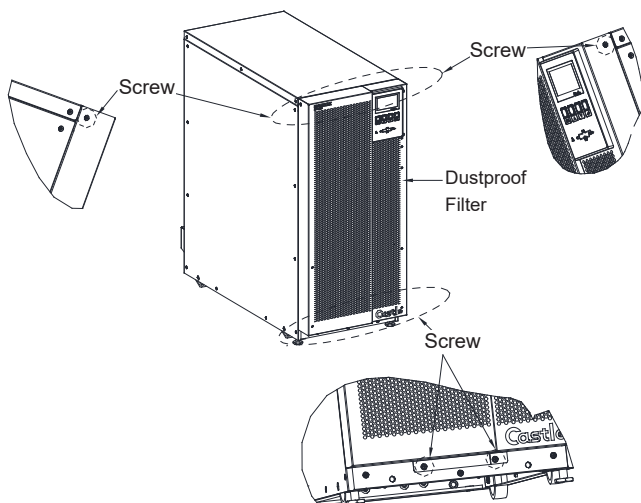

3C3 PRO 60-20KS Dustproof Filter

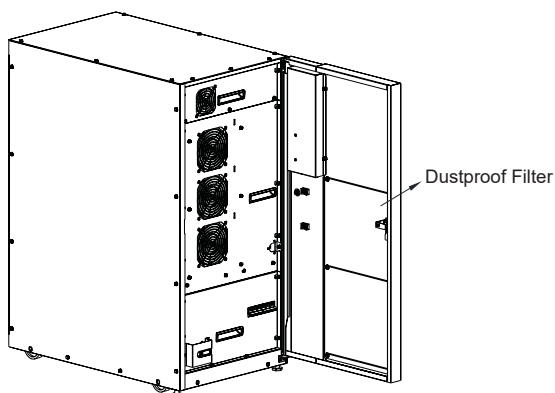

6.2 Temperature Sensor

For battery with short lifetime and being sensitive to temperature, the temperature sensor can be used to detect the temperature change, enable the temperature compensation function of charge voltage, the battery charge voltage will be adjusted automatically to prolong the lifetime of the battery.

6.3 Single Power Input

The 3C3 PRO Series 20-80kVA models can be used to change the standard dual power input to a single power input via the supplied power jumper according to customer requirements.

Chapter 7 Transportation, Maintenance and Troubleshooting

Transporting the UPS

Prepare for transporting the UPS according to the following steps:

Note: Special equipment, such as a forklift, is needed for loading and unloading due to the heavy weight of the UPS.

1. Turn off all equipment that is being powered by the UPS, and disconnect all connectors to the power terminal of the UPS.
2. Disconnect the UPS from utility power and turn off the battery.

Servicing and Maintenance

The 3C3 PRO series require only minimal maintenance.

1. If the battery is disconnected, loads will not be protected from power failure.
2. Under normal circumstances, early replacement should be made if the battery is found not in good condition. The battery should only be replaced by qualified personnel. Users should not replace the battery themselves. The following precautions should be observed:
 - A. Turn off and disconnect the UPS from the AC mains prior to battery replacement.
 - B. Remove watches, rings, or other metal objects.
 - C. Use screwdrivers with insulated handles, and do not lay tools or metal objects on the battery. Otherwise the battery can present a risk of electrical shock or explosion from high short-circuits current.
 - D. Short circuit or reverse connection between the positive and negative terminals of the battery is strictly forbidden.
3. It is not recommended to replace batteries individually. All batteries should be replaced at the same time only by authorized personnel following the instructions from the battery supplier.
4. Keep the air inlets and outlets clear for proper ventilation and clean side frames and fan vents from dust every 6 months (disconnect the UPS from utility power and turn off the battery prior to the cleaning).

Troubleshooting

Go through the following checklist if the UPS is operating abnormally:

1. Check if the input wiring of the UPS is connected correctly.
2. Check if any over-current circuit breaker has tripped.
3. Check if input voltage is within the specified limits.

If the problem remains unsolved after you go through the checklist above, please refer to "Table of Malfunctions" and "Reference Table of LED Indicators" in Appendix II for further instructions.

Symptom	Table of Malfunctions	Solution
	LCD Display or Possible cause	
The fault LED is lit, periodic beeps	Overloaded in bypass or inverter mode	Remove some load. Loading level shall be less than the nominal power capacity.
	Mains out of tolerance	Check that the input wiring and input voltage are normal
	Battery disconnected	Check the battery breaker and the battery wiring
The fault LED is lit, continuous beeps	UPS fault	
Battery discharging time less than 1/3 of initial discharging time	Battery exhausted	Contact SANTAK customer service center
	Charger fault	
LCD panel has no display		Long press ESC 3S, LCD replacement.

If the problem persists, please contact SANTAK local distributors or email to santak_int@caton.com, and provide the following information:

- MODEL and SERIAL NO of the UPS;



TYPE: 3C3 PRO-20KS Uninterruptible Power Supply
INPUT: AC380/400/415V, 3W+N+PE, 50/60Hz, 32/31/29A, Icc:10kA
BYPASS: AC380/400/415V, 3W+N+PE, 50/60Hz, 30/29/28A, Icc:10kA
OUTPUT: AC380/400/415V, 3W+N+PE, 50/60Hz, 30/29/28A, 20kVA/18kW
BATTERY: DC384V,41A,Icc:10kA (Please refer to user manual for details.)

9106-52241

MFG P/N:

9106-52241-XX

P/N:

3CN02CC50412024

CTO:

4LXXLAAXX

S/N:



SANTAK ELECTRONICS (SHENZHEN) CO., LTD
Address: No. 8 Baoshi Road, Baoan District, Shenzhen

- The date when the problem arose.
- A complete description of the problem (including indications from the LCD panel, LED indicators, horns, and power condition and load capacity).

Appendix I Specifications

3C3 PRO 20KS/30KS/40KS/60KS/80KS Specifications

Models	3C3 PRO 20KS	3C3 PRO 30KS	3C3 PRO 40KS	3C3 PRO 60KS	3C3 PRO 80KS
Rated Capacity	20KVA/18KW	30KVA/27KW	40KVA/36KW	60KVA/54KW	80KVA/72KW
Input Type	Three Phase + Neutral Wire + Ground Wire				
Frequency	42 - 72Hz				
Power Factor	≥ 0.99				
Input	AC Mains Voltage Range Rating: 230/400Vac (Optional: 220/380, 240/415) 100% Load: 190/330 to 276/478Vac (-15%, +20%) 50% Load: 116/201 to 276/478Vac (-50%, +20%)				
Bypass Voltage Range	Rating: 230/400Vac (Optional: 220/380, 240/415) 207/359 to 253/438Vac (Default Rated Voltage Range: ± 10%, Maximum Optional Range: ±20%)				
Rated Voltage	230/400 Vac, Three Phase + Neutral Wire + Ground Wire, (Optional: 220/380, 240/415)				
Power Factor	0.9				
Frequency Tolerance	(42-72)Hz ± 4Hz				
Overload Time	60 min for 102-110% load, 10 min for 111-125% load, 1 min for 126-150% load, and 150 ms for >151% load at an ambient temperature of 40°C.				
Double-conversion Mode	94%				
ECO Mode	98%				

Ambient Temperature	0-40°C			
Storage Temperature	-15 ~ +55°C with the protective package in good conditions			
Humidity	5-95%, noncondensing			
Operating Altitude	No derating within 1,000m above sea level; The maximum operating altitude: 2,000m; The UPS should be derated by 1% for every 100m increase.			
Models	3C3 PRO 20KS	3C3 PRO 30KS	3C3 PRO 40KS	3C3 PRO 60KS 3C3 PRO 80KS
Rated Capacity	20KVA/18KW	30KVA/27KW	40KVA/36KW	60KVA/54KW 80KVA/72KW
Place	Indoor			
Dusty	Well			
Storage Temperature	< 40 °C			
Storage Humidity	< 70% RH			
Other	With original package			
Nominal Battery Voltage/ Rated Charging Voltage	336V (168 Cells) to 432V (216 Cells), default setting: 384V (192 Cells)			
Net Weight (without battery)	61.5Kg	67Kg	93Kg	177Kg 184Kg
Gross Weight (without battery)	87.5Kg	75Kg	101Kg	223Kg 230Kg
Dimensions (W x D x H) (mm)	350×805×800 350×805×800 350×805×800 600×720×1200 600×720×1200			
National Safety Standards of China	GB4943			
TLC Certification	YD/T1095			
National Safety Standards of China International Safety Standards	GB/T260.2 IEC/62040.2			
EMC	WARNING: This product is intended for commercial and industrial application in the secondary environment. Installation restrictions or additional measures may be needed to prevent disturbances.			

3C3 PRO 20KS/30KS/40KS/60KS/80KS Specifications

Models	3C3 PRO 100KS	3C3 PRO 120KS	3C3 PRO 160KS	3C3 PRO 200KS
Rated Capacity	100KVA/90KW	120KVA/108KW	60KVA/144KW	200KVA/180KW
Input Type	Three Phase + Neutral Wire + Ground Wire			
Frequency	42 - 72Hz			
Power Factor	≥ 0.99			
Input	AC Mains Voltage Range Rating: 230/400Vac (Optional: 220/380, 240/415) 100% Load: 190/330 to 276/478Vac (-15%, +20%) 50% Load: 116/201 to 276/478Vac (-50%, +20%)			
	Bypass Voltage Range Rating: 230/400Vac (Optional: 220/380, 240/415) 207/359 to 253/438Vac (Default Rated Voltage Range: ±10%, Maximum Optional Range: ±20%)			
Output	Rated Voltage 230/400 Vac, Three Phase + Neutral Wire + Ground Wire, (Optional: 220/380, 240/415)			
	Power Factor 0.9			
	Frequency Tolerance (42-72)Hz±4Hz			
	Overload Time 60 min for 102-110% load, 10 min for 111-125% load, 1 min for 126-150% load, and 150 ms for >151% load at an ambient temperature of 40 °C .			
Efficiency	Double-conversion Mode 94%			
	ECO Mode 98%			
Operating Environment	Ambient Temperature 0-40°C			
	Storage Temperature -15 ~ +55°C with the protective package in good conditions			
	Humidity 5-95%, noncondensing			
	Operating Altitude No derating within 1,000m above sea level; The maximum operating altitude: 2,000m; The UPS should be derated by 1% for every 100m increase.			

Models	3C3 PRO 100KS	3C3 PRO 120KS	3C3 PRO 160KS	3C3 PRO 200KS
Rated Capacity	100KVA/90KW	120KVA/108KW	60KVA/144KW	200KVA/180KW
Storage condition for UPS and spare parts store one year (refer unit SN).	Indoor	Indoor	Well	< 40 °C < 70% RH With original package
Nominal Battery Voltage/ Rated Charging Voltage	336V (168 Cells) to 432V (216 Cells), default setting: 384V (192 Cells)			
Weight	283Kg	311Kg	457Kg	457Kg
	351Kg	379Kg	525Kg	525Kg
Dimensions (W x D x H) (mm)	600 × 800 × 1876			
Safety Standards	National Safety Standards of China TLC Certification YD/T 1095 GB4943			
EMC	National Safety Standards of China International Safety Standards GB/7260.2 IEC/62040.2			
WARNING: This product is intended for commercial and industrial application in the secondary environment. Installation restrictions or additional measures may be needed to prevent disturbances.				

Non-default battery section configuration Make sure you get confirmation with the Santak sales or technical support team.

Appendix II Reference Table of LED Indicators

NO	Status	LED					Buzzer
		Bypass LED	Mains LED	Inverter LED	Battery LED	Fault LED	
1	Mains Mode						
	Normal		●	●			
	Warning		●	●		●	★
2	Bypass Mode						
	Normal	●					
	Warning	●				●	★
3	Battery Mode						
	Normal			●	●		
	Warning			●	●	●	★
4	Battery ECT						
	Normal	●		●	●		
	Warning	●		●	●	●	★
5	ACECT						
	Normal	●	●	●			
	Warning	●	●	●		●	★
6	ECO Mode						
	Normal	●		●			
	Warning	●		●		●	★
7	LOAD OFF						
	Normal						
	Warning					●	★

If there is no LED status in the table above be found in your equipment, please contact authorized distributors or email to santak_int@eaton.com.

- Indicator light is on
- The working cycle of buzzer is 3s: ringing 0.5s and being silent for 2.5s.

For more specific failure information, please contact SANTAK service representative.

Appendix III Warranty

The company provides: two-year free warranty service from the date of purchase. For repair or replacement of the warranted items, please provide

Valid certification by an authorized distributor;

- The serial number of your product.

In case of product failures, please call local distributors or email to santak_int@eaton.com. SANTAK's customers are entitled to the following services:

- Two-year warranty;
- 24-hour toll-free hot line service;
- Nationwide warranty;
- Online technical support service;
- Free on-site repair within the warranty period of UPS.

The warranty does not cover:

- Human initiated failures;
- Failures that occur after the warranty expires;
- Items of which the serial numbers are changed or lost;
- Damage or loss caused by force majeure;
- Items that underwent unauthorized disassembly or modification;
- Failures arising from no-compliance with operation instruction;
- Damages arising from battery over discharge or human irritated damages.

山特电子(深圳)有限公司

www.santak.com.cn

厂址: 深圳市宝安72区宝石路8号

邮编: 518101

客服热线: 400-830-3938/800-830-3938

客服传真: (0755)27572730

客服中心 E-mail 地址:

upsservice@eaton.com

注: “SANTAK”、“山特”、“”等注册商标均属山特电子(深圳)有限公司所有